

Applied Molding

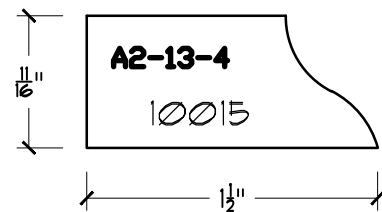

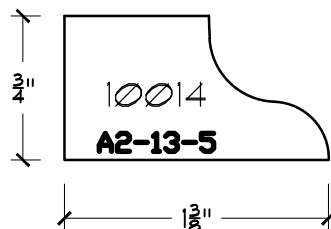

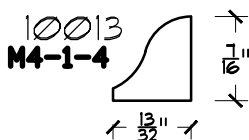

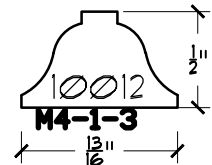
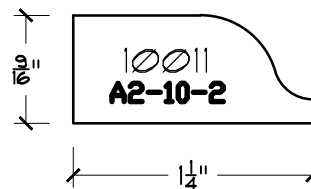
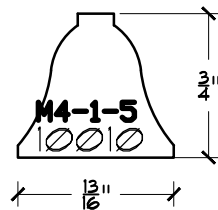
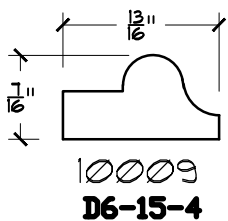
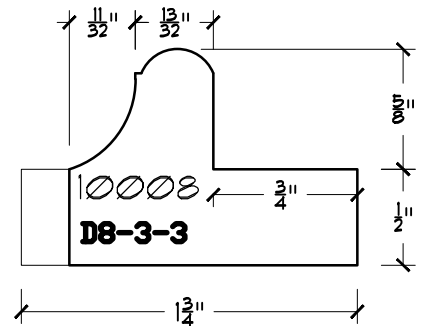
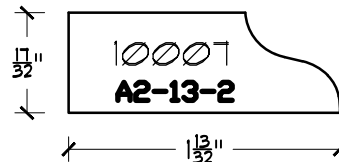
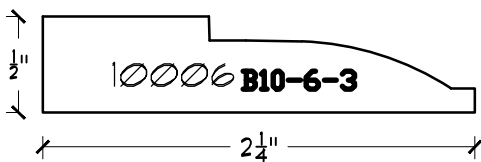
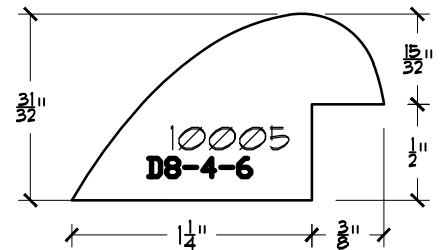
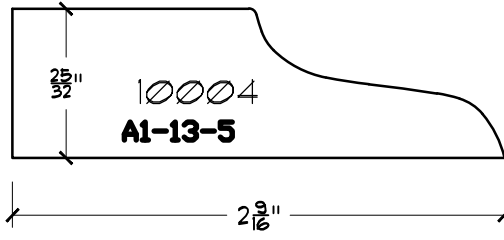
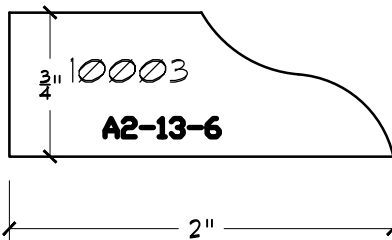
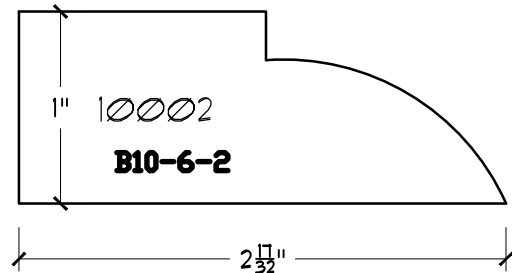
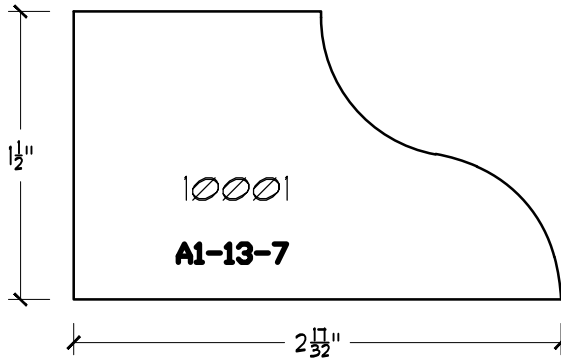
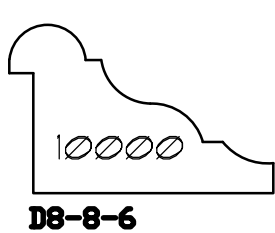
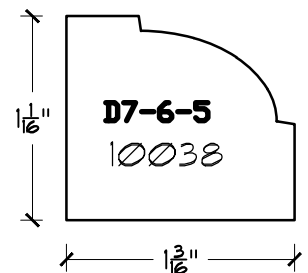
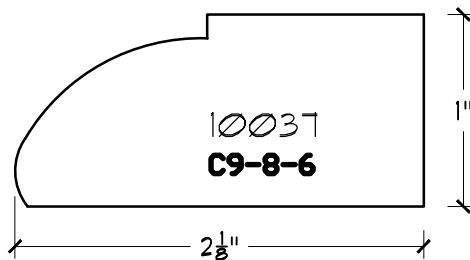
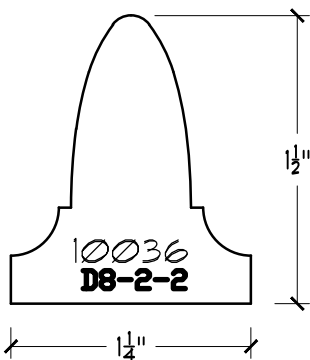
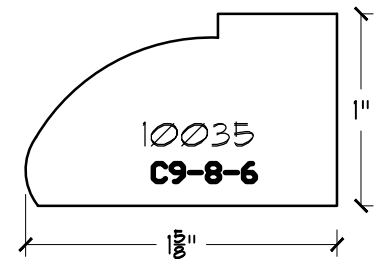
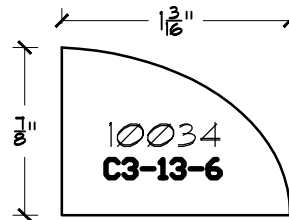
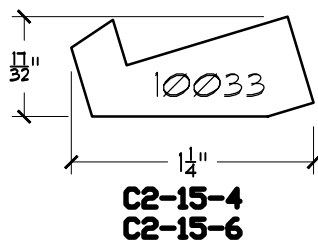
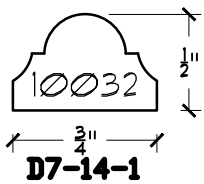
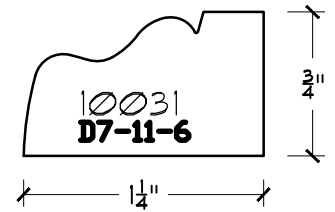
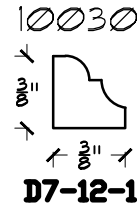
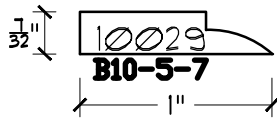
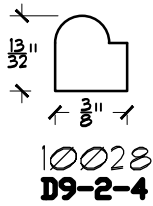
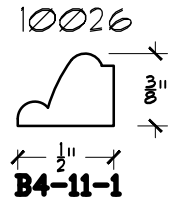
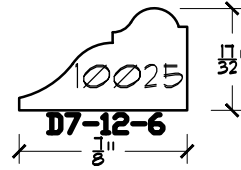
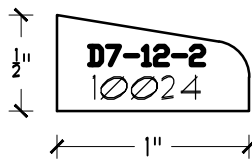
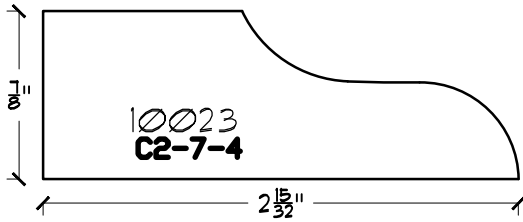
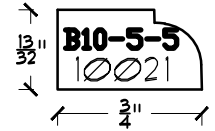
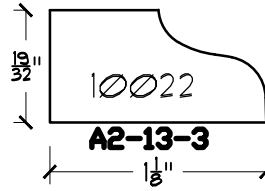
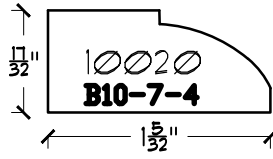
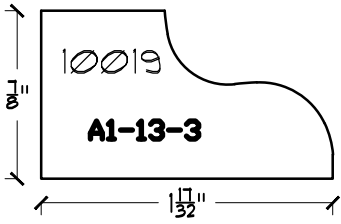
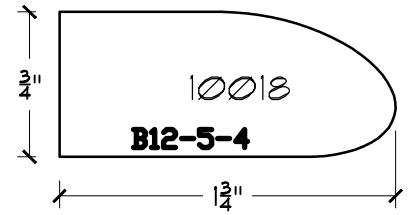
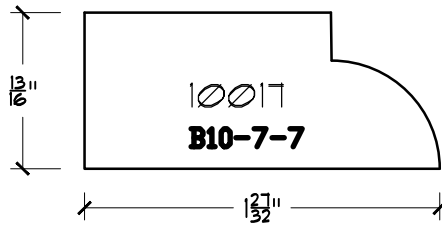
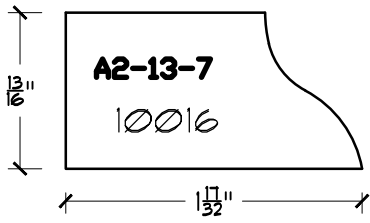
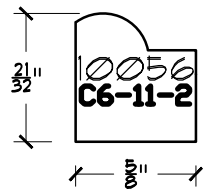
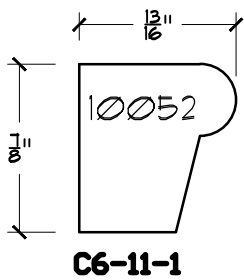
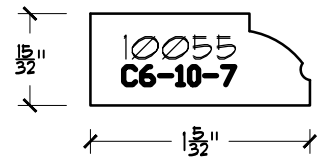
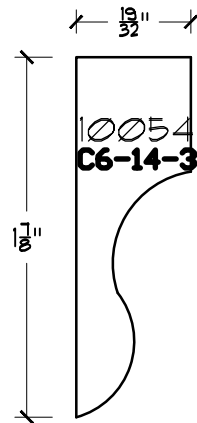
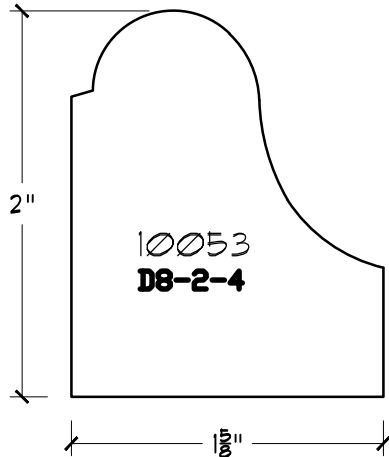
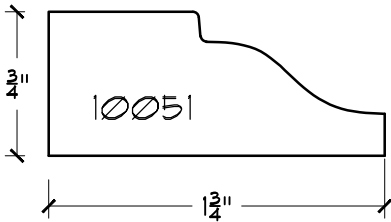
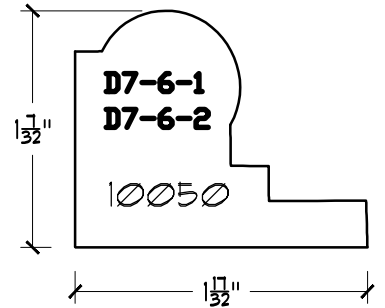
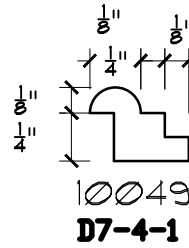
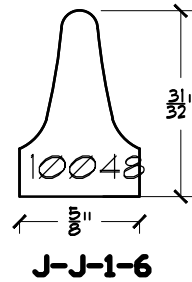
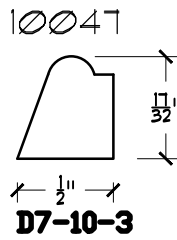
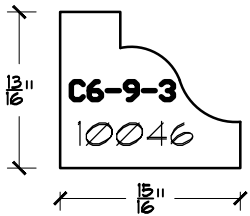
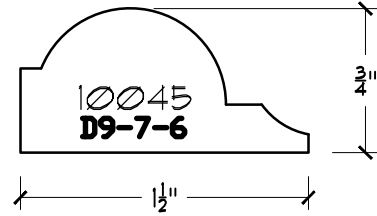
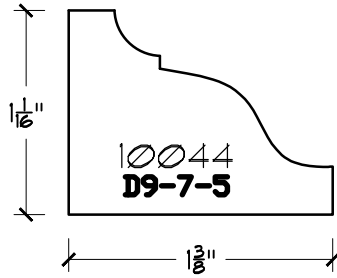
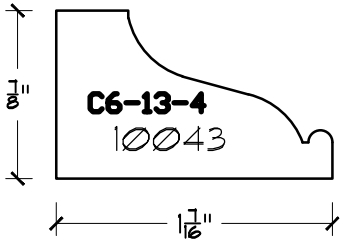
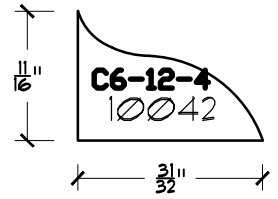
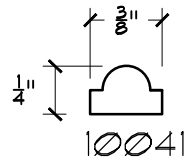
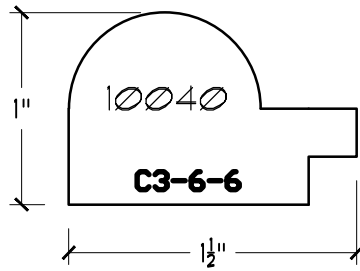
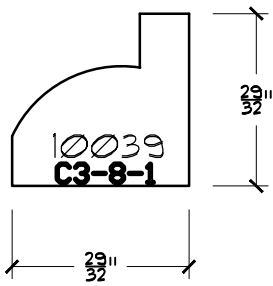
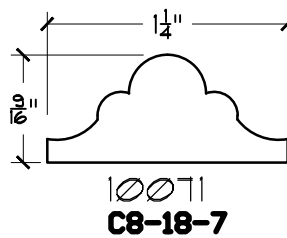
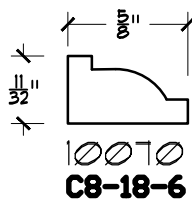
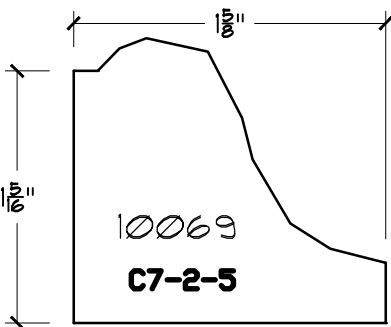
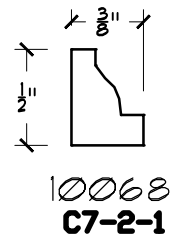
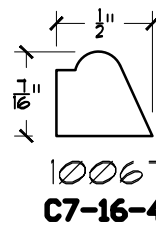
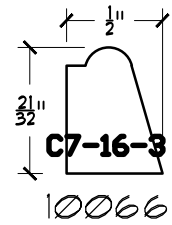
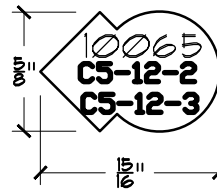
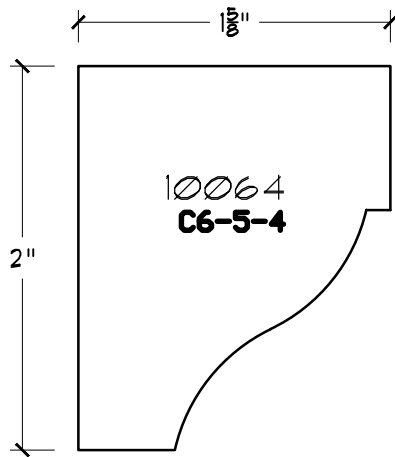
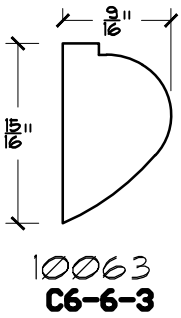
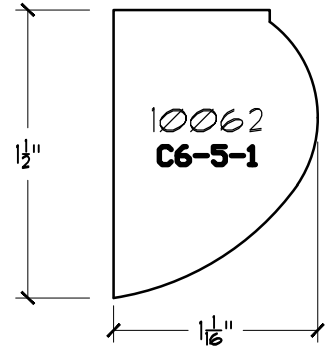
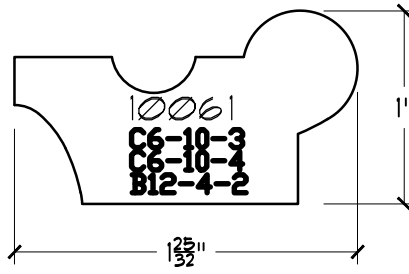
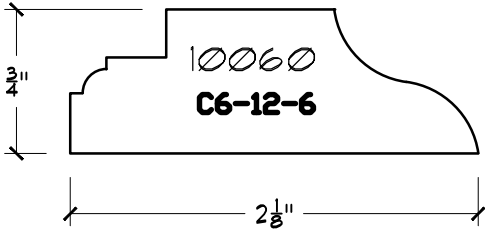
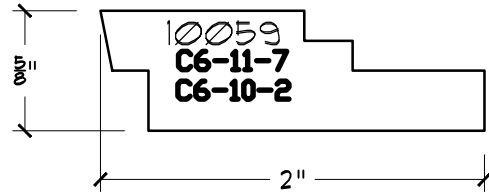
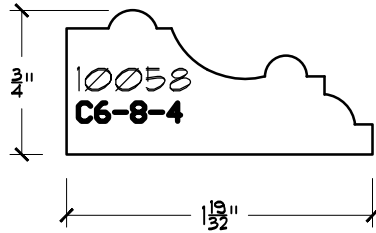
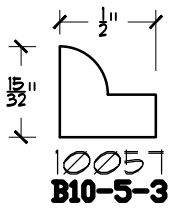

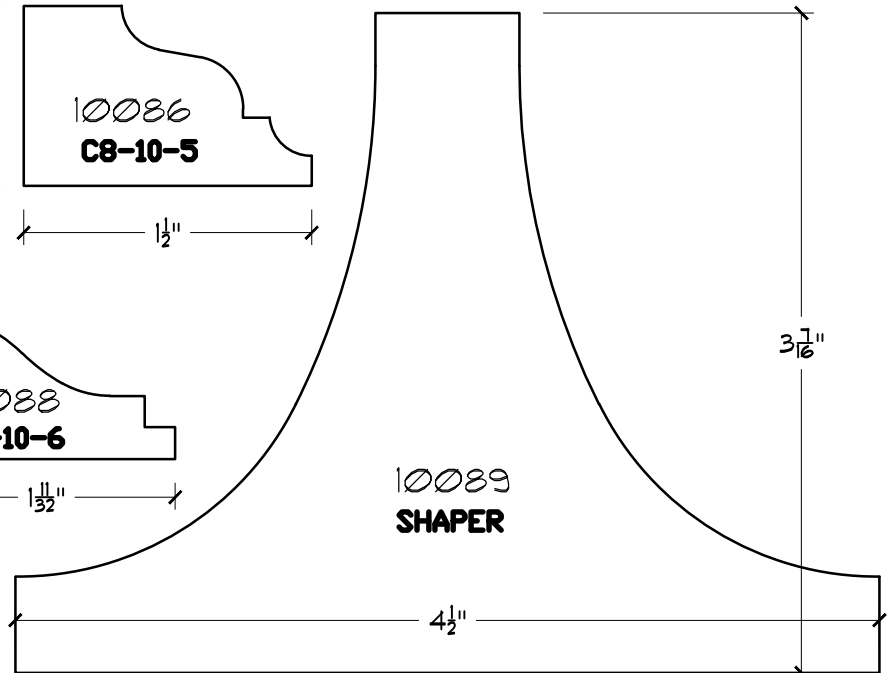
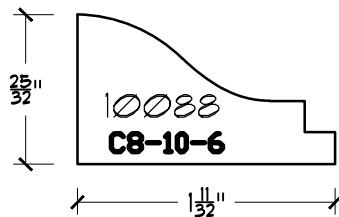
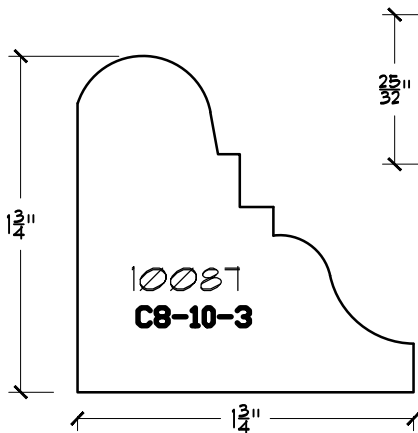
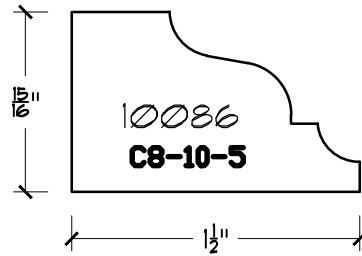
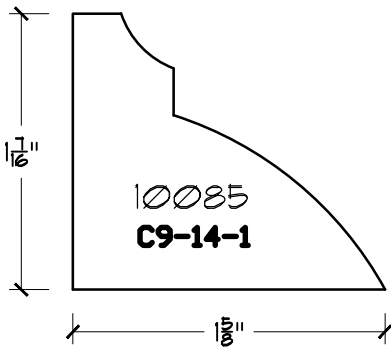
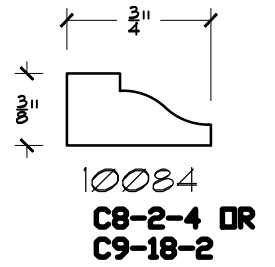
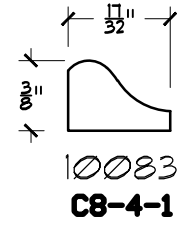
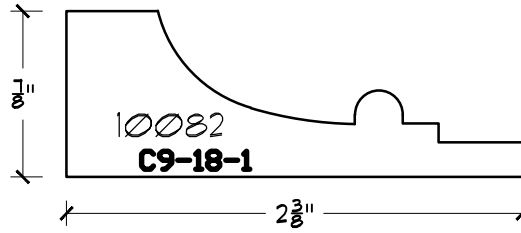
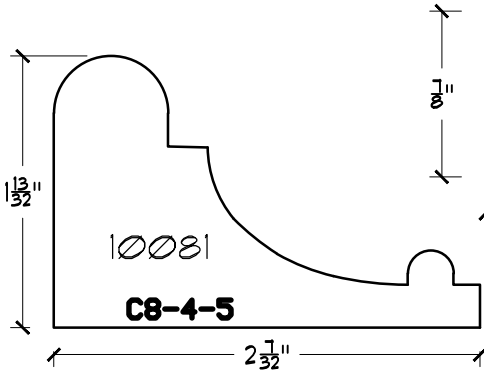
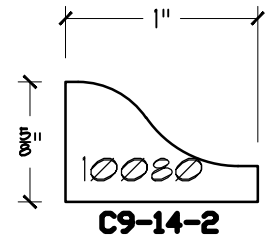
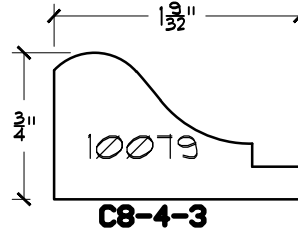
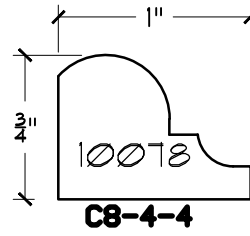
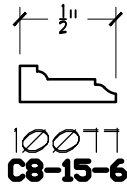
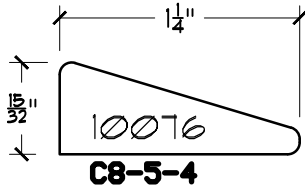
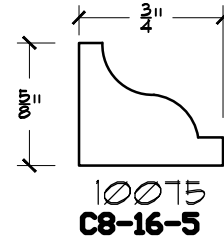
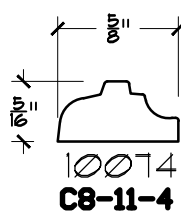
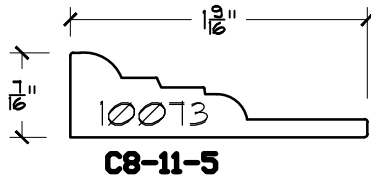
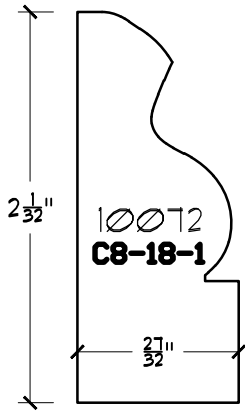

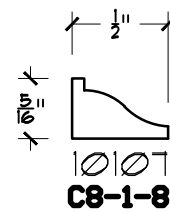
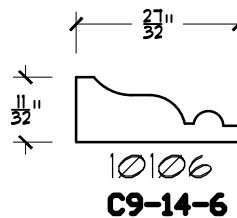
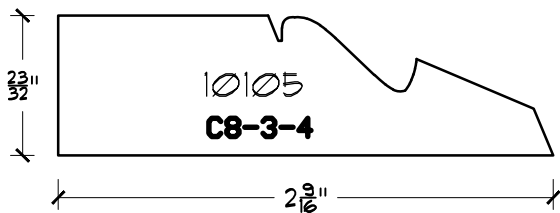
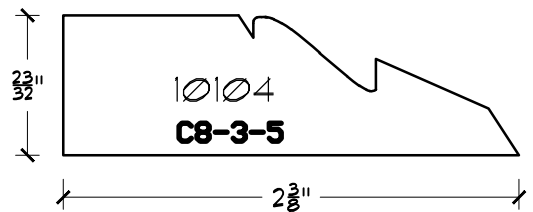
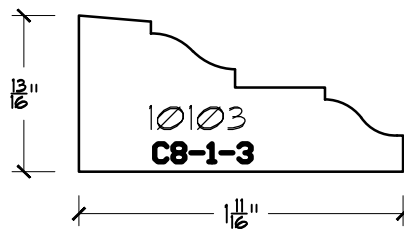
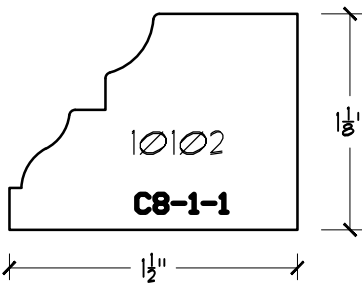
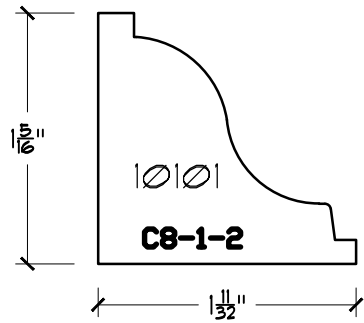
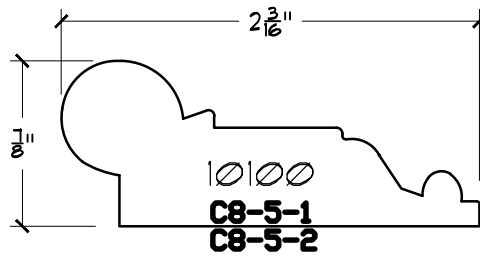
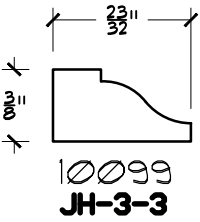
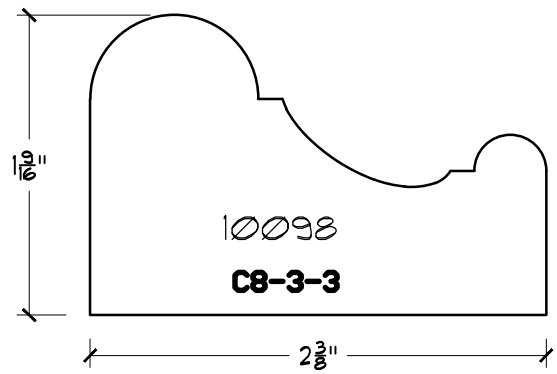
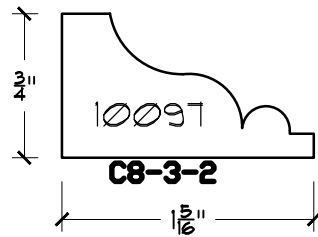
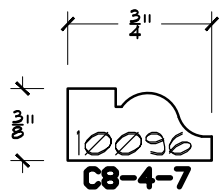
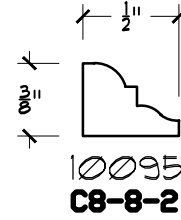
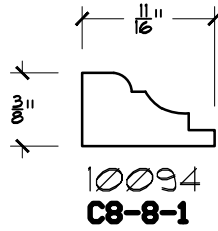
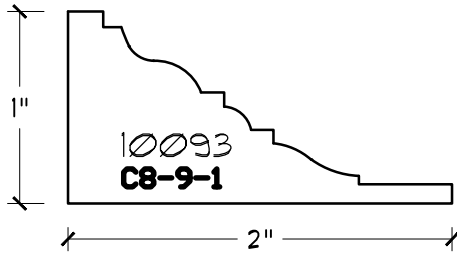
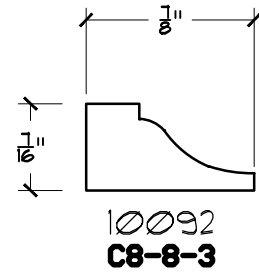
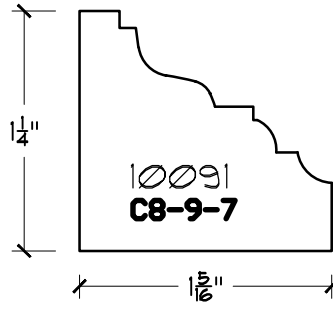
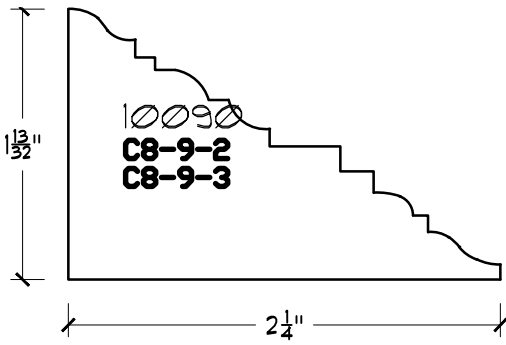

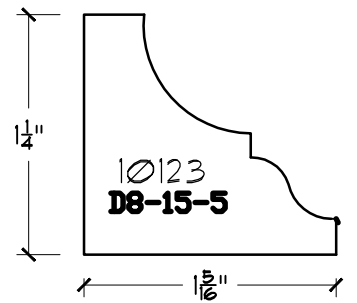
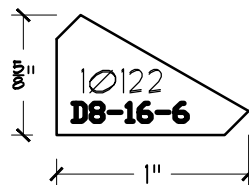
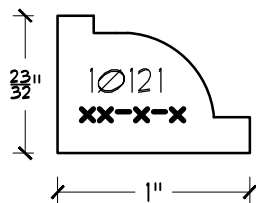
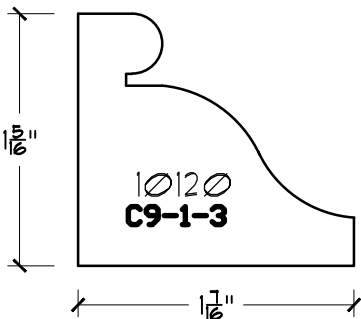
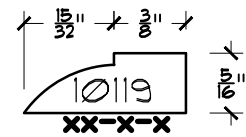
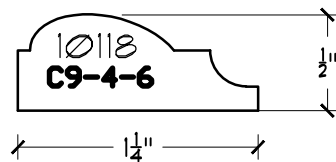
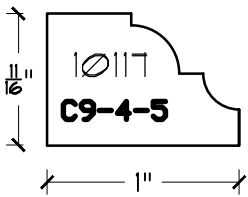
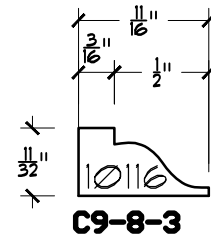
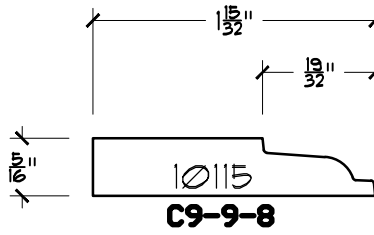
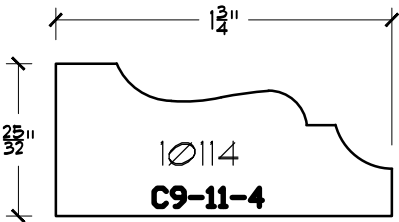
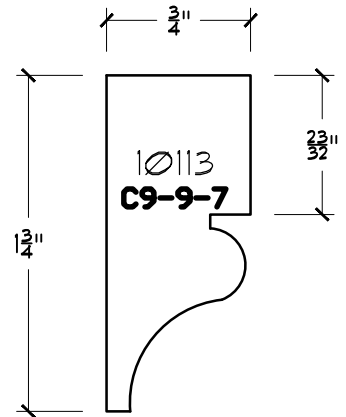
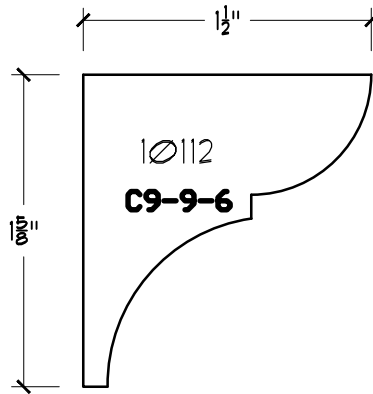
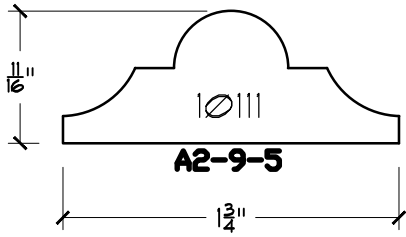
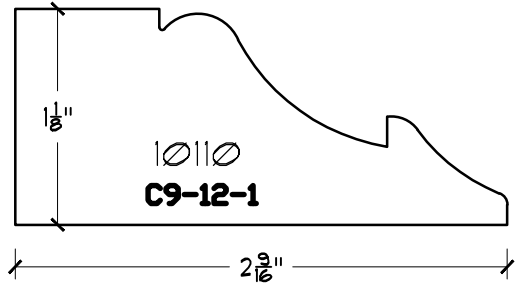
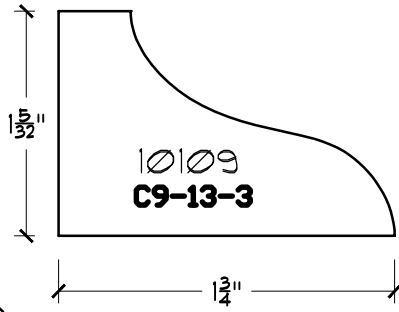
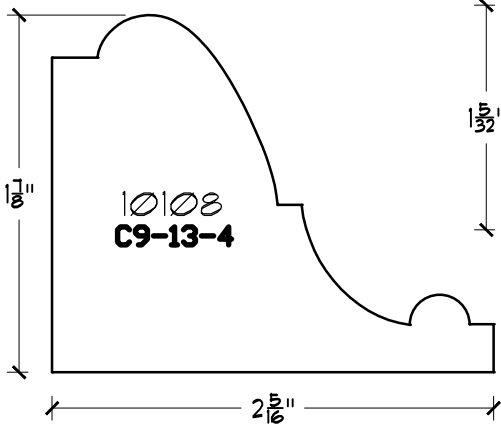

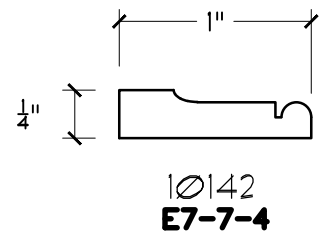
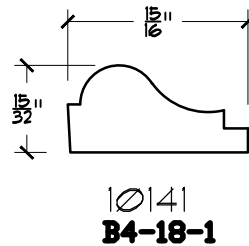
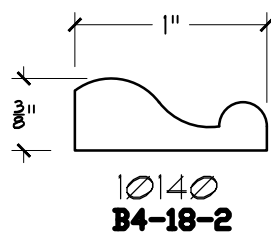
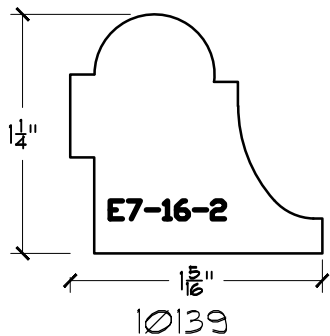
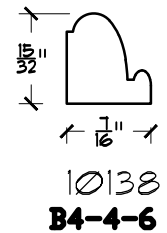
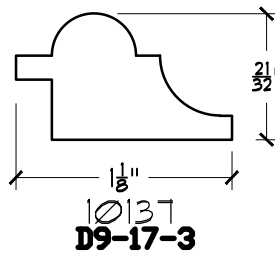
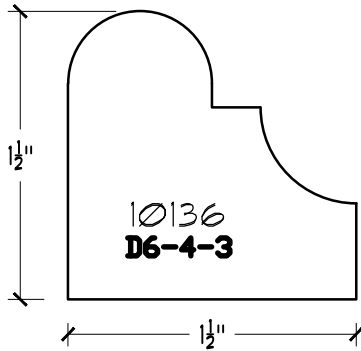
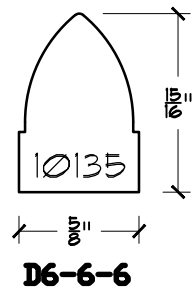
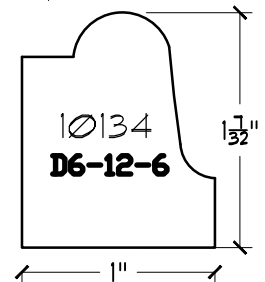
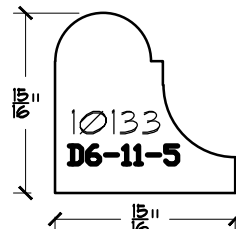
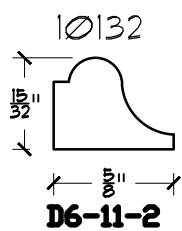
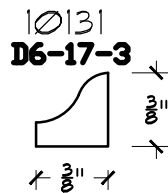
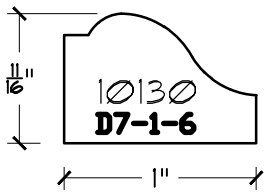
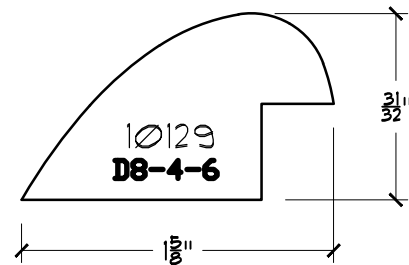
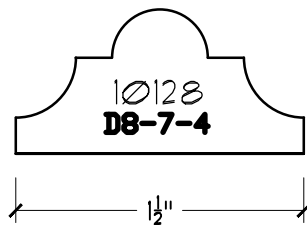
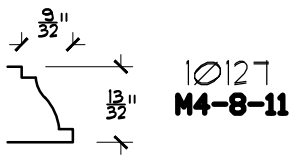
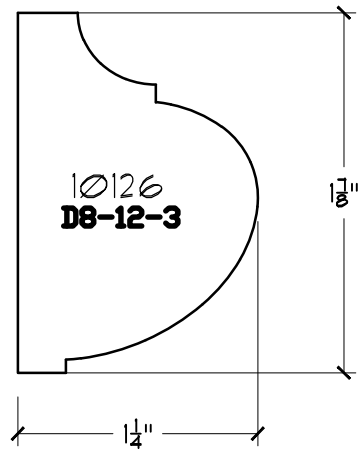
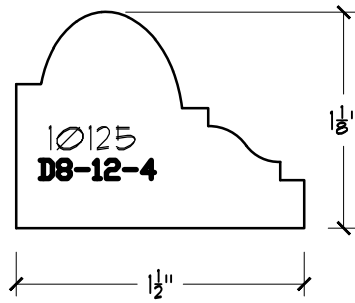
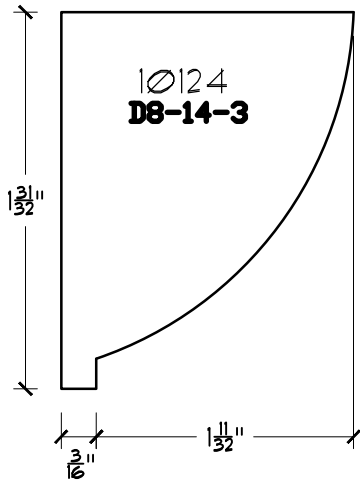

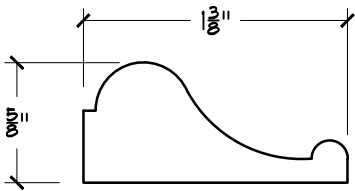

10143
E7-16-5

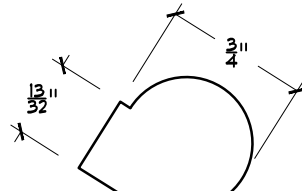

10144
B4-17-7
B4-17-8

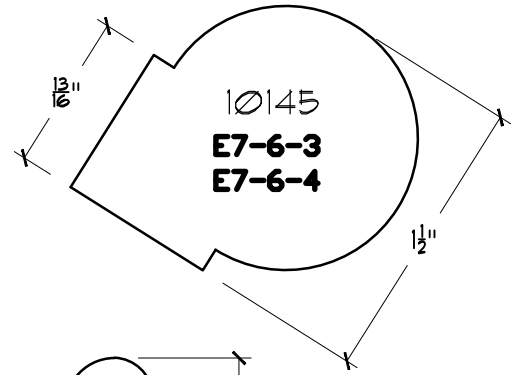

10145
E7-6-3
E7-6-4

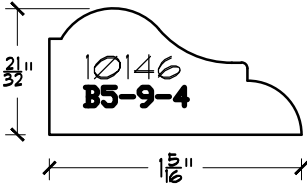

10146
B5-9-4

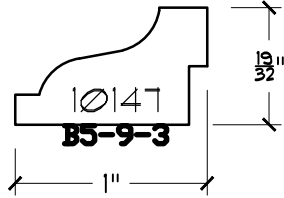

10147
B5-9-3

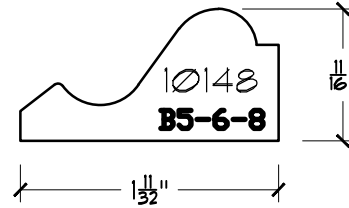

10148
B5-6-8

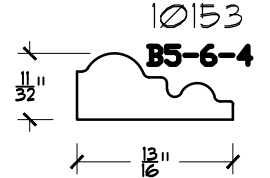

10153
B5-6-4

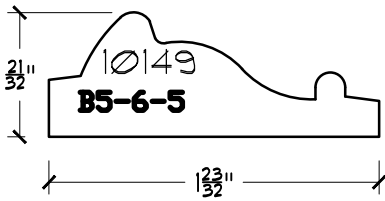

10149
B5-6-5

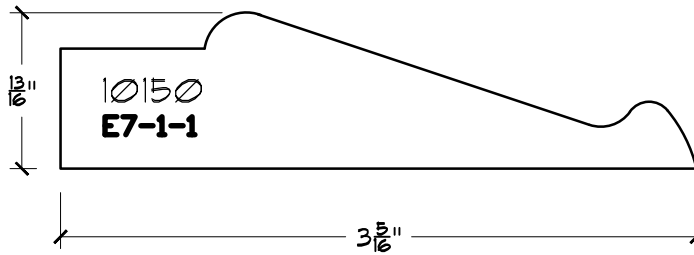

10150
E7-1-1

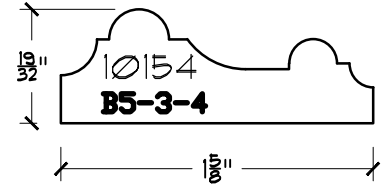

10154
B5-3-4

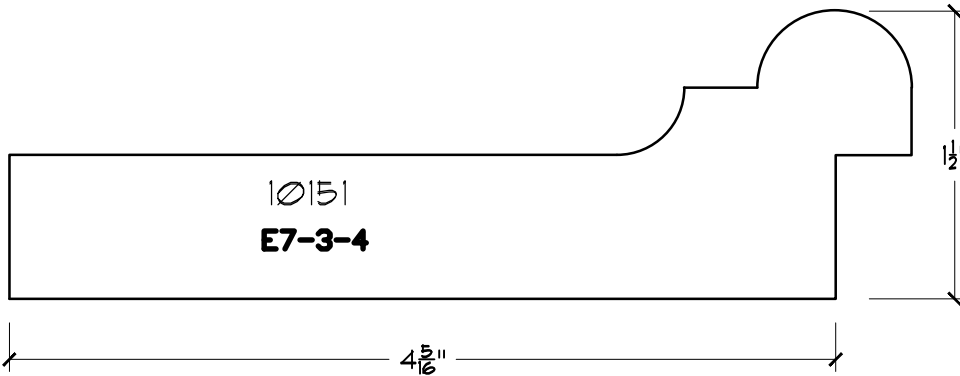

10151
E7-3-4

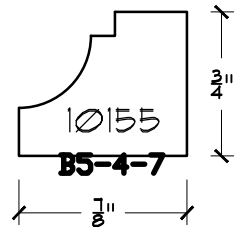

10155
B5-4-7

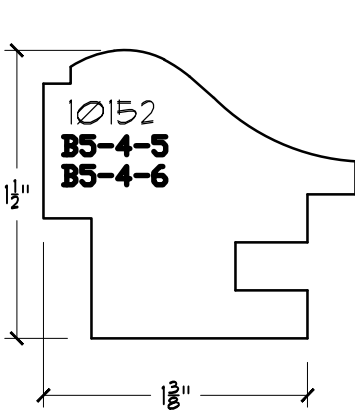

10152
B5-4-5
B5-4-6

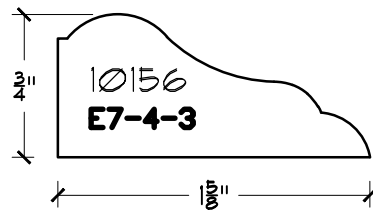

10156
E7-4-3

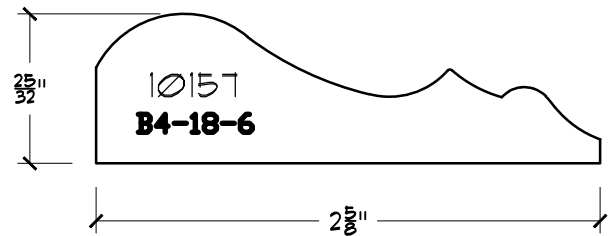

10157
B4-18-6

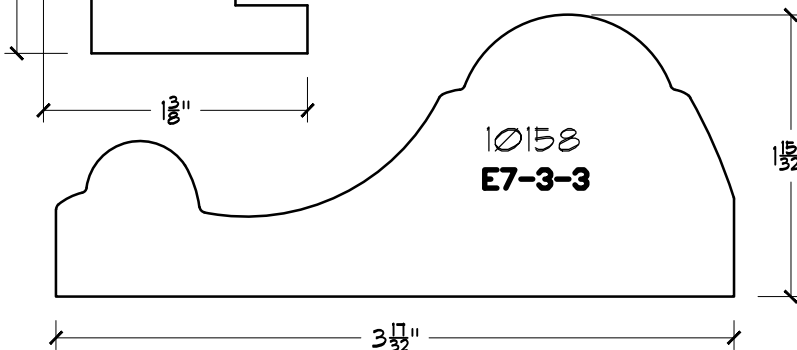

10158
E7-3-3

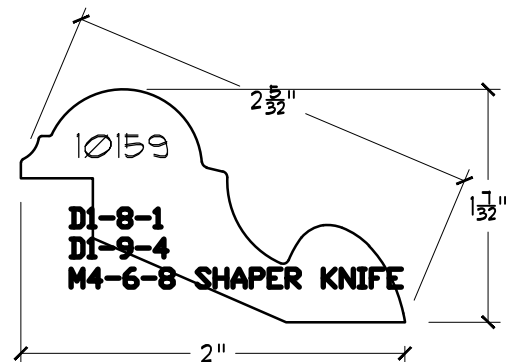

10159
D1-8-1
D1-9-4
M4-6-8 SHAPER KNIFE

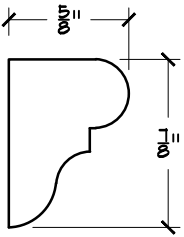

10160
B5-12-4

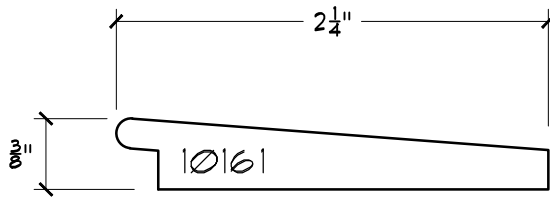

10161
B5-12-5
B5-12-6

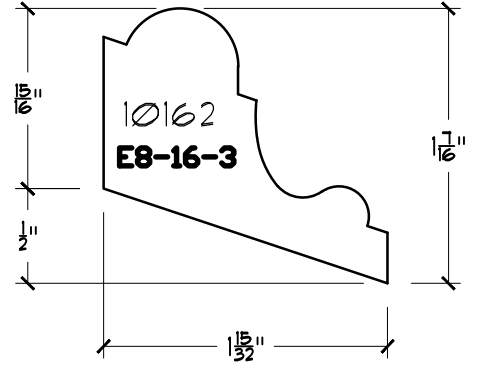

10162
E8-16-3

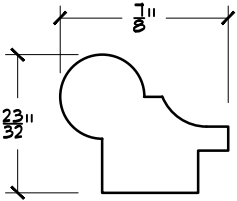

10163
B5-12-7
B5-12-8

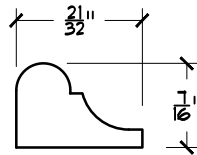

10164
B5-8-5

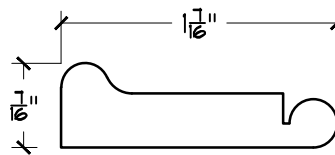

10165
B5-8-7
B5-8-8

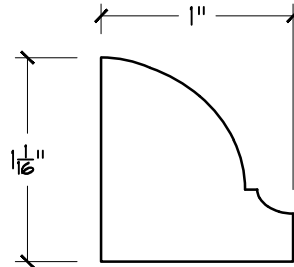

10166
B8-13-6

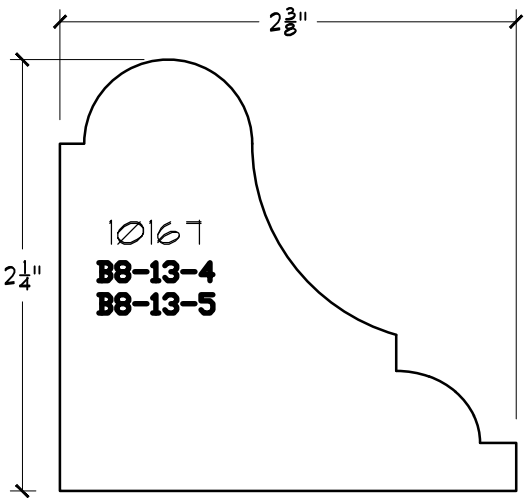

10167
B8-13-4
B8-13-5

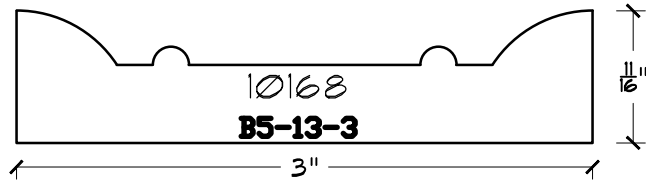

10168
B5-13-3

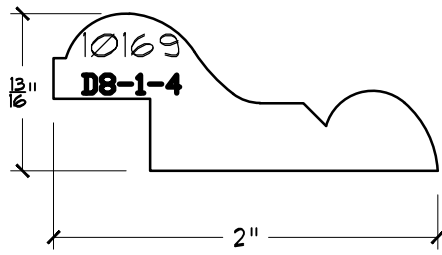

10169
D8-1-4

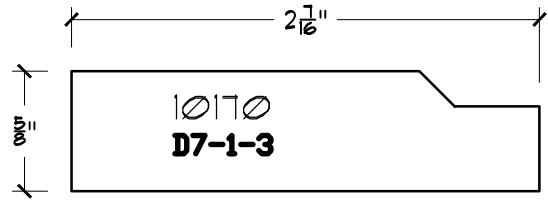

10170
D7-1-3

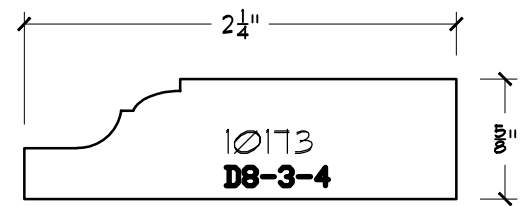

10173
D8-3-4

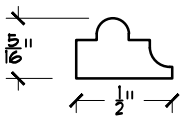

10171
D8-1-1

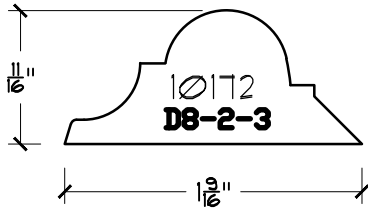

10172
D8-2-3

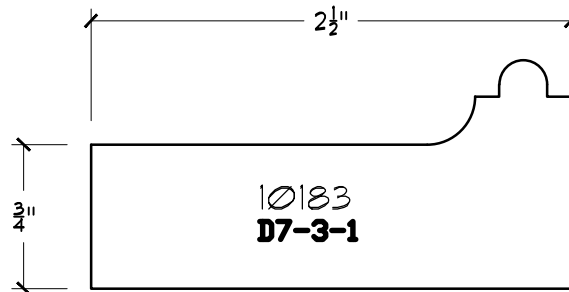
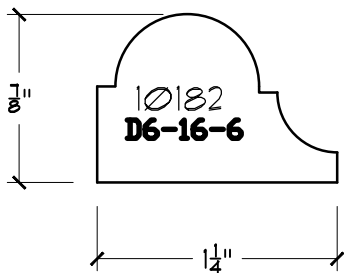
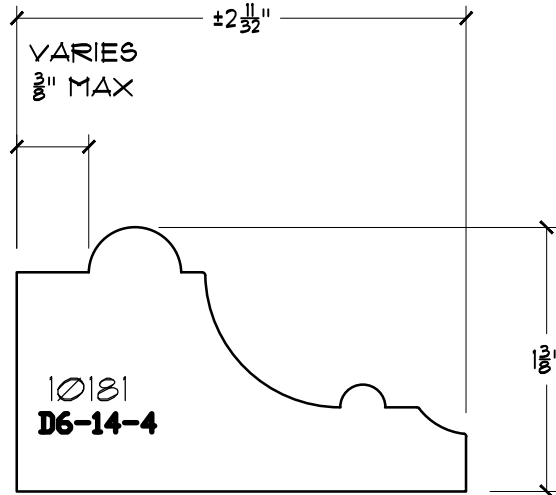
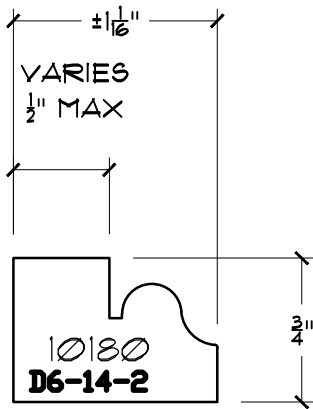
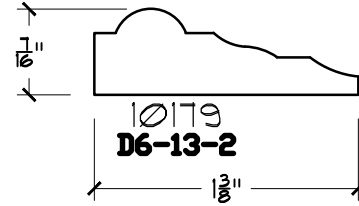
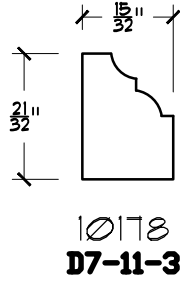
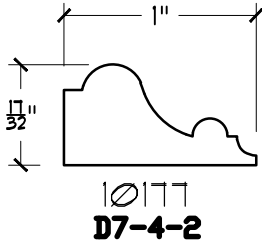
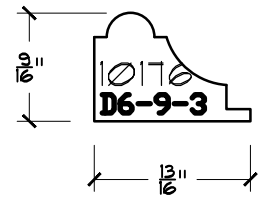
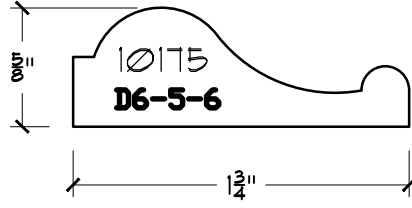
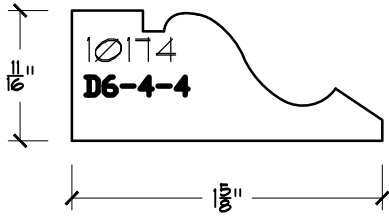

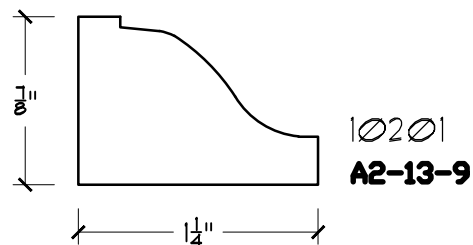
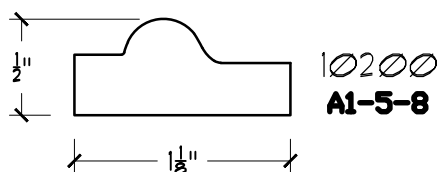
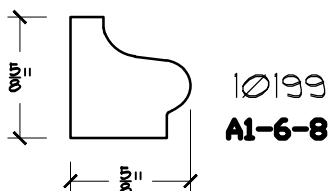
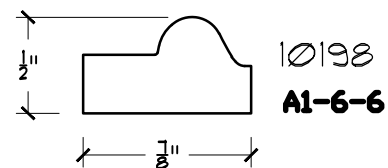
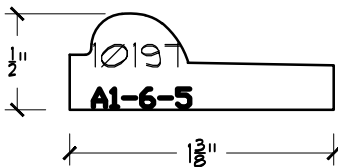
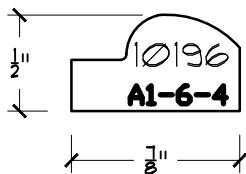
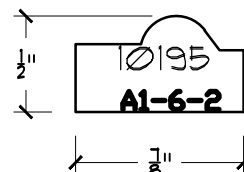
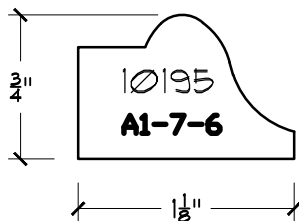
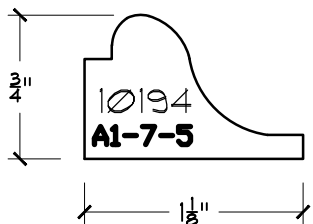
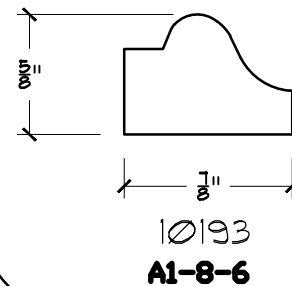
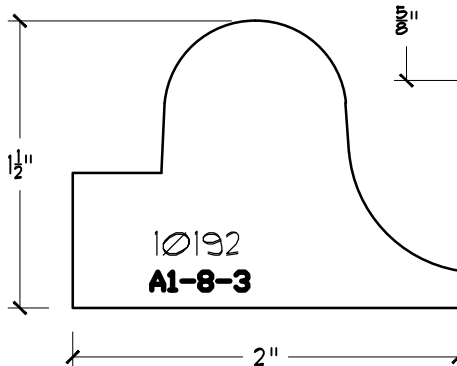
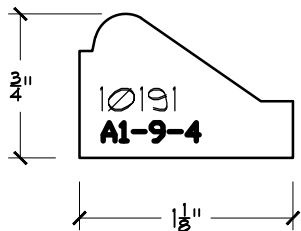
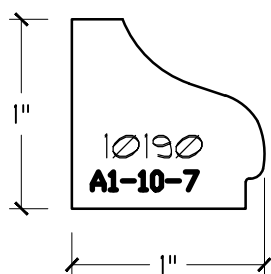
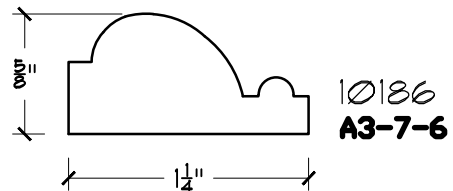
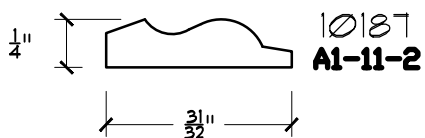
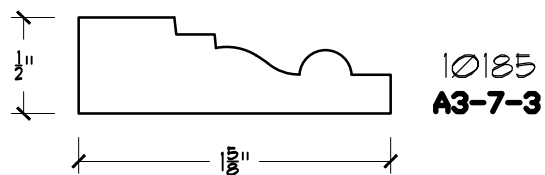
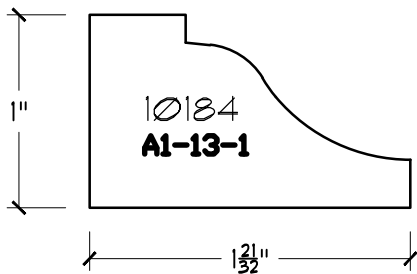

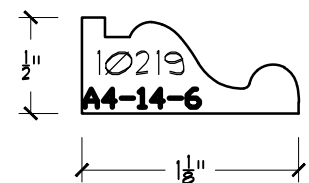
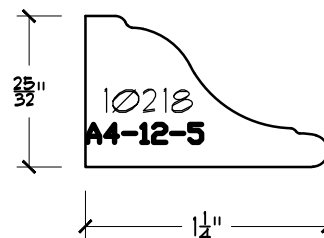
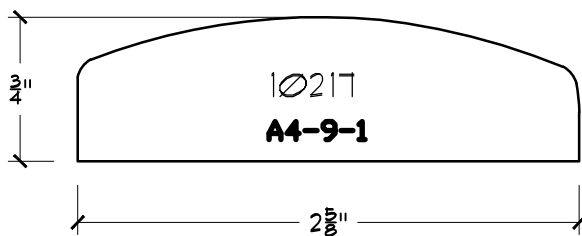
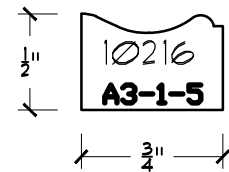
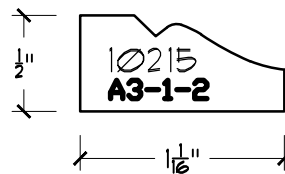
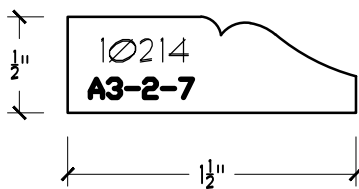
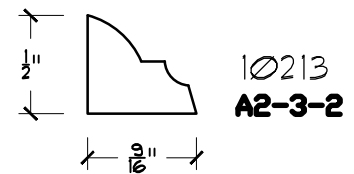
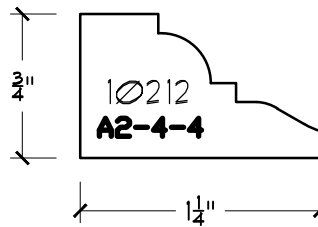
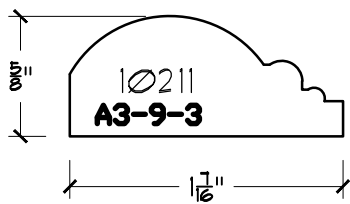
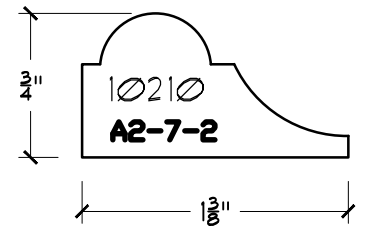
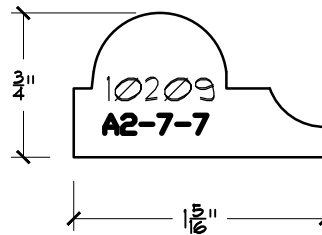
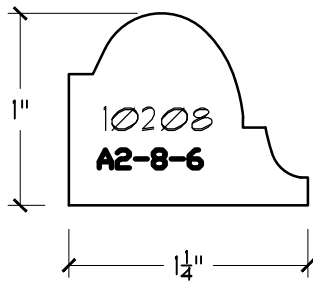
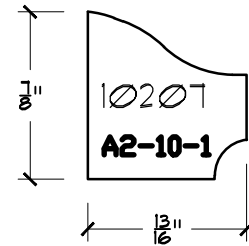
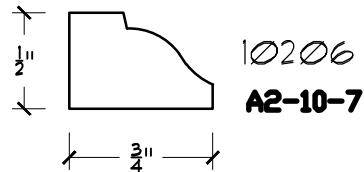
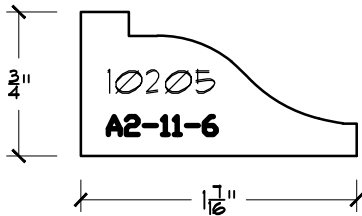
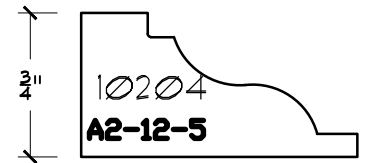
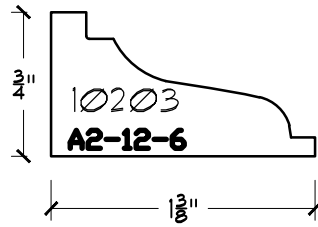
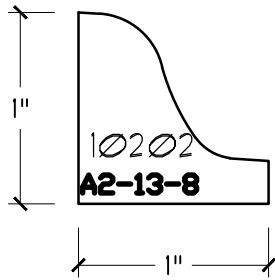

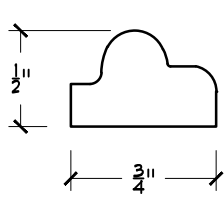

10220
A5-3-6

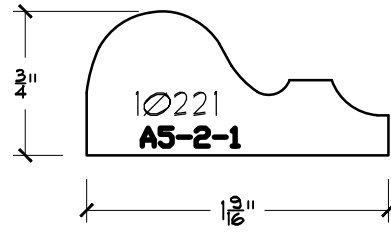

10221
A5-2-1

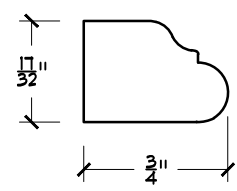

10222
A5-8-5

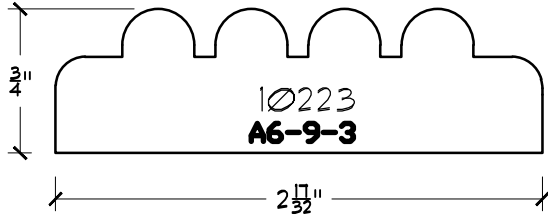

10223
A6-9-3

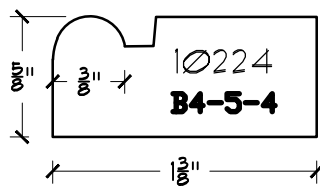

10224
B4-5-4

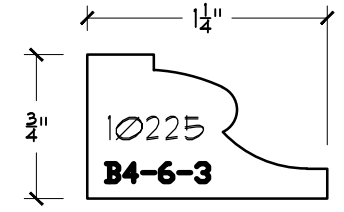

10225
B4-6-3

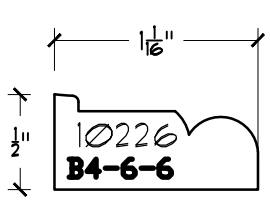

10226
B4-6-6

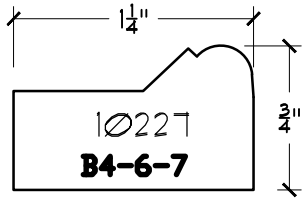

10227
B4-6-7

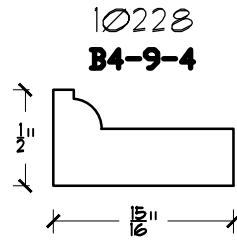

10228
B4-9-4

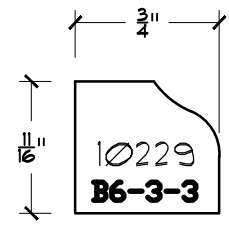

10229
B6-3-3

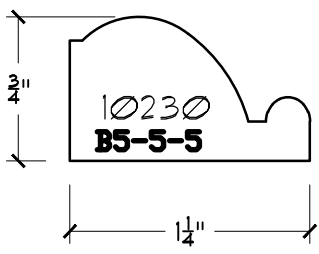

10230
B5-5-5

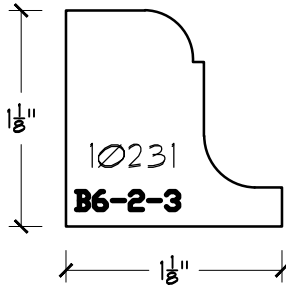

10231
B6-2-3

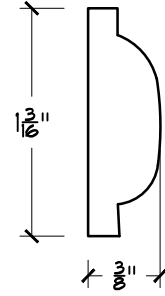

10232
B6-5-2

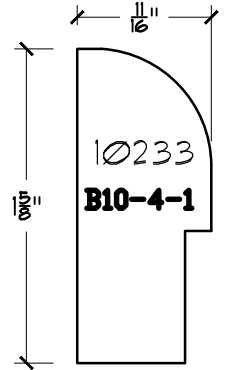

10233
B10-4-1

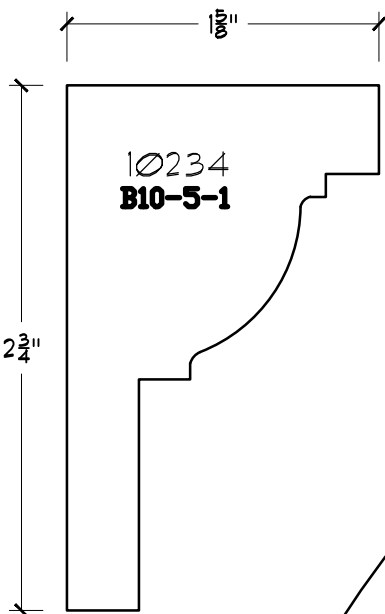

10234
B10-5-1

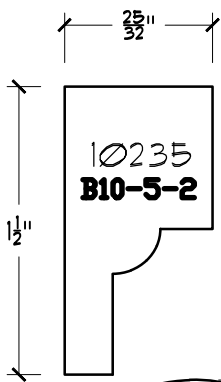

10235
B10-5-2

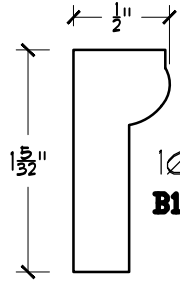

10236
B11-1-3

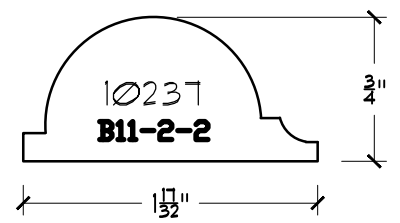

10237
B11-2-2

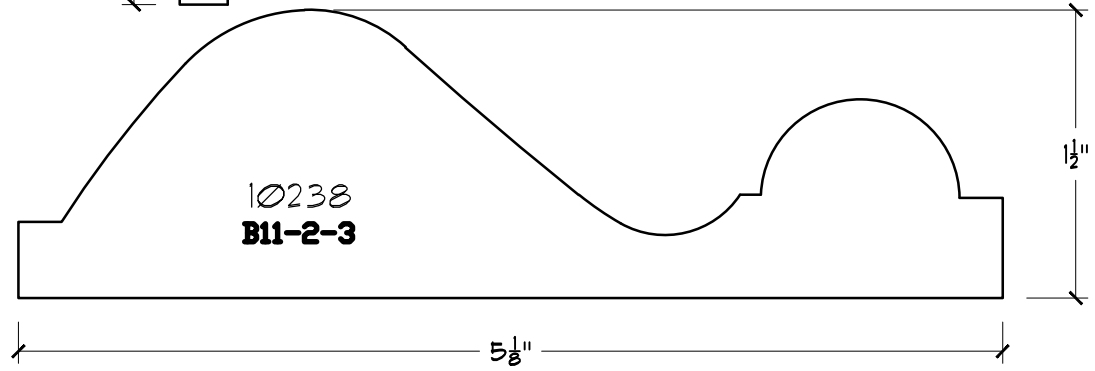

10238
B11-2-3

