

# Casing

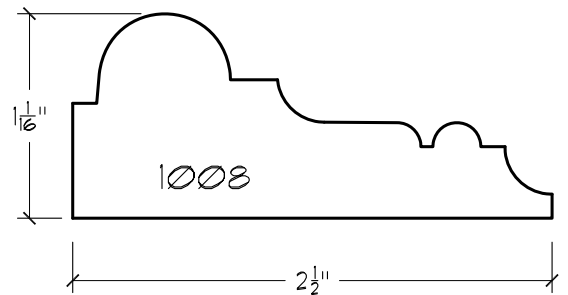

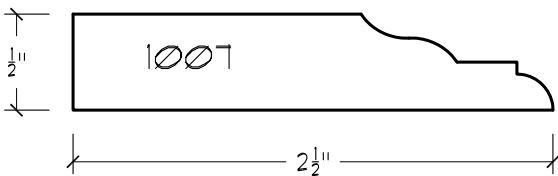

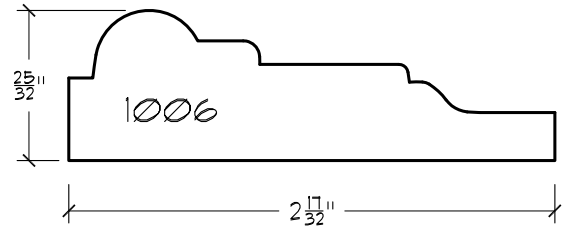

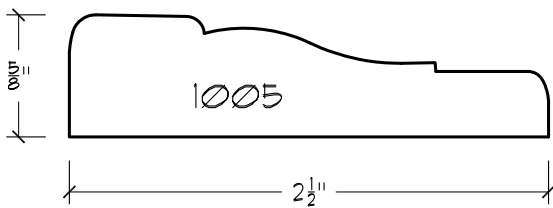
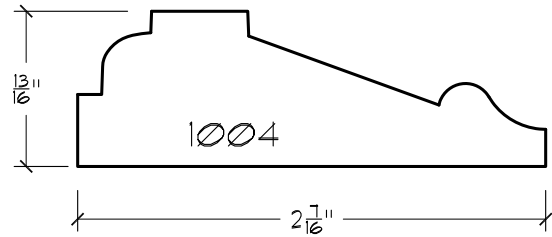
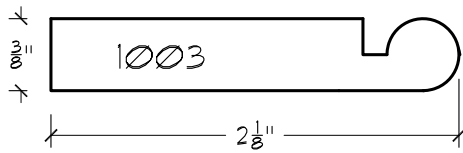
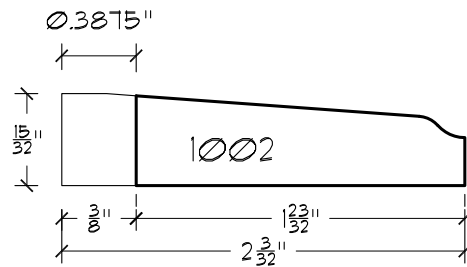
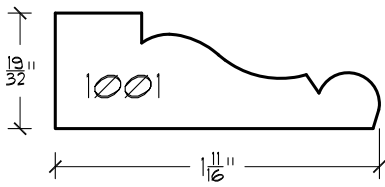
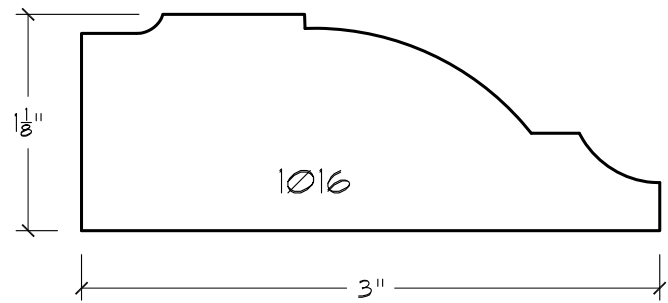
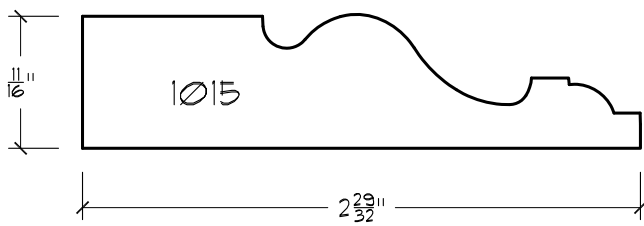
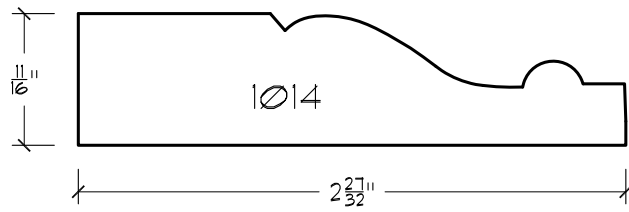
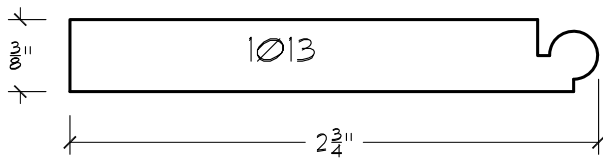
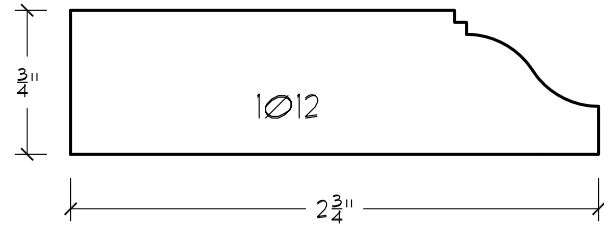
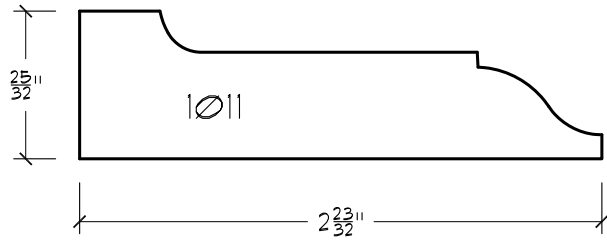
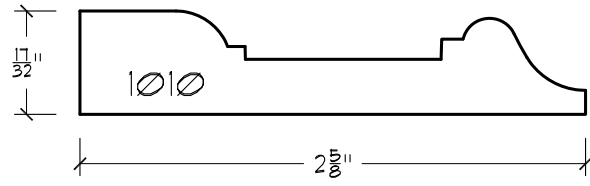
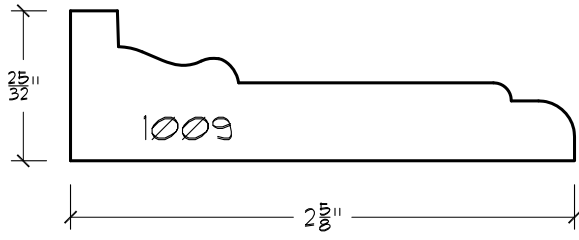
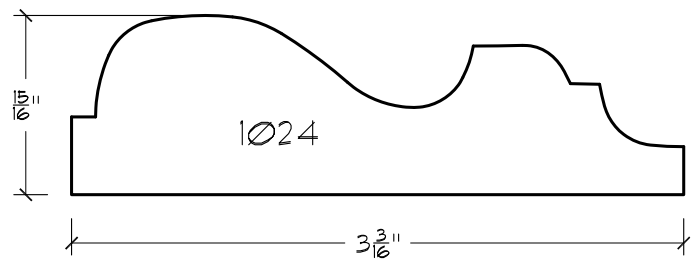
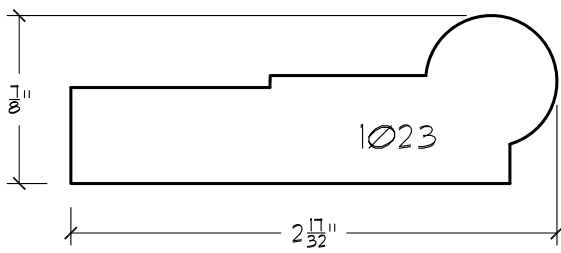
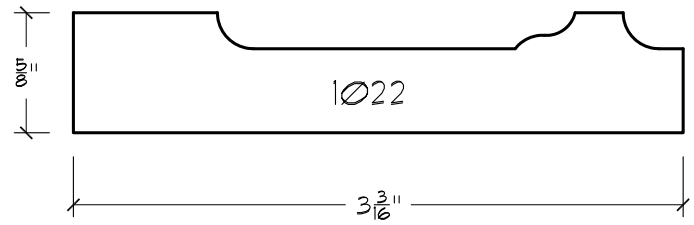
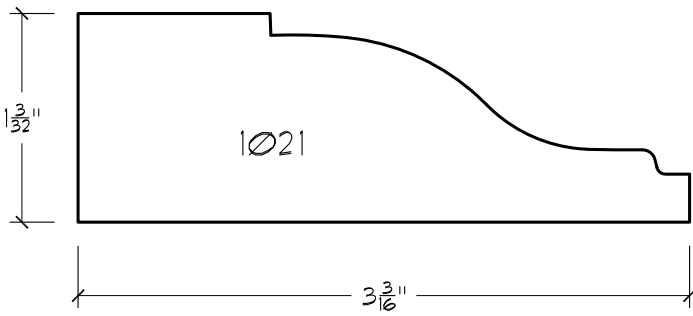
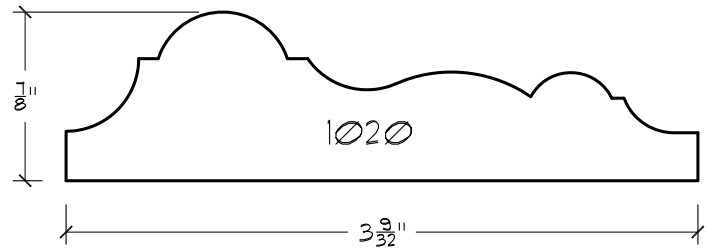
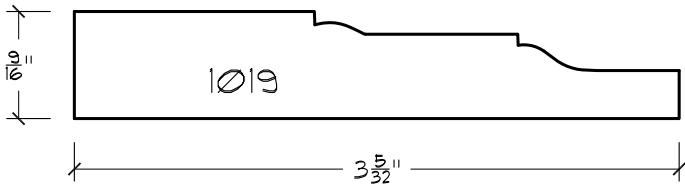
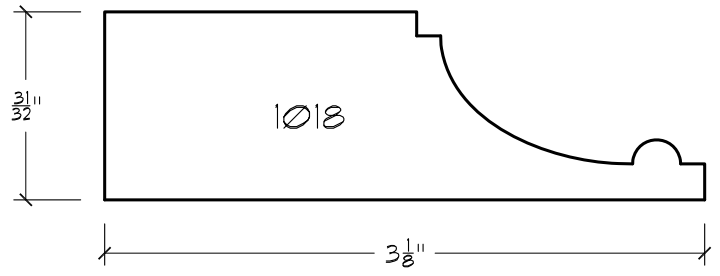
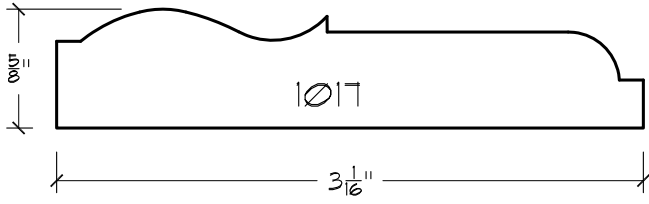
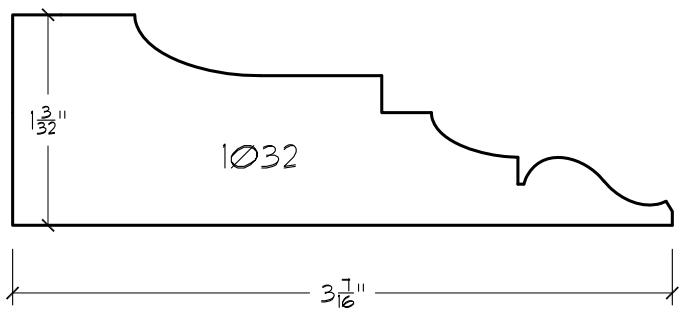
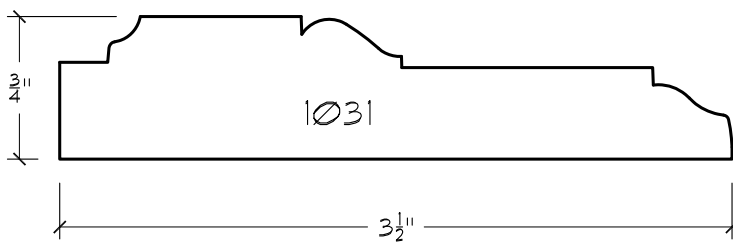
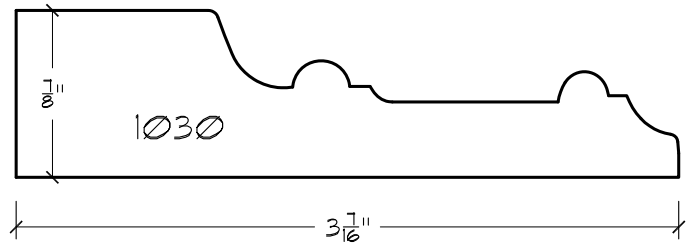
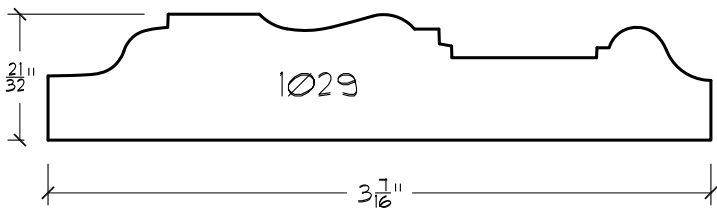
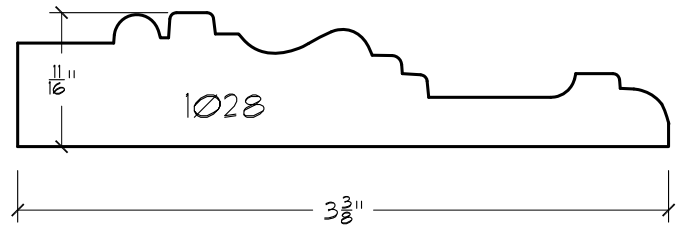
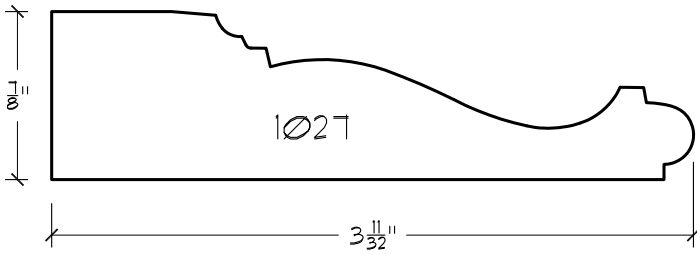
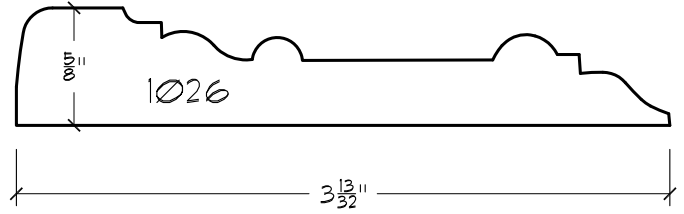
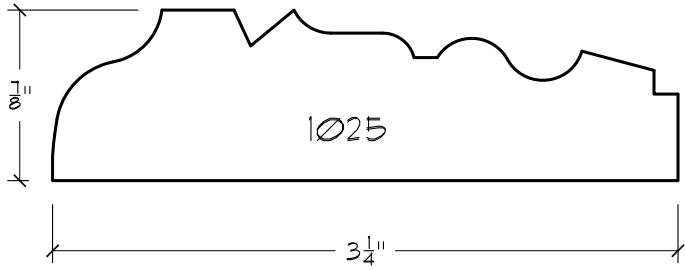

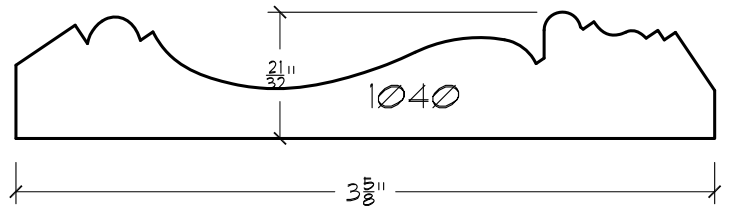
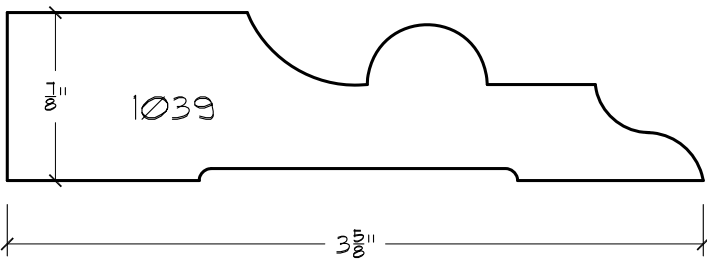
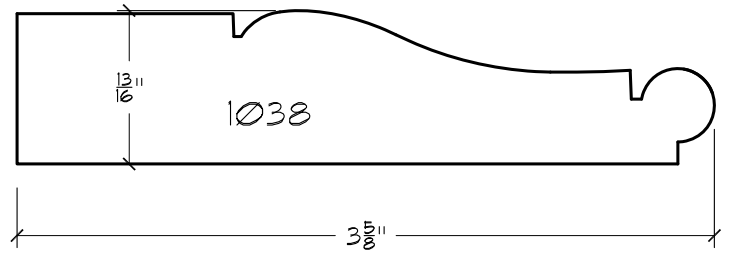
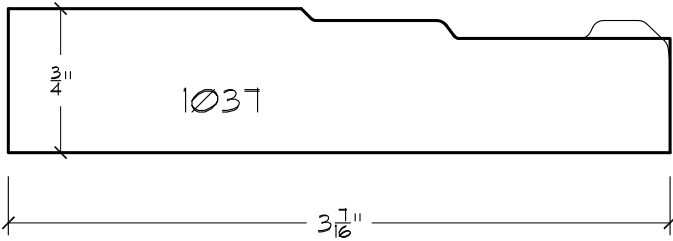
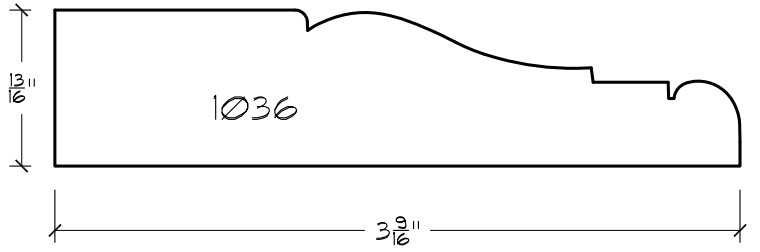
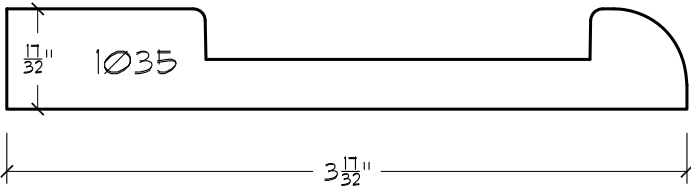
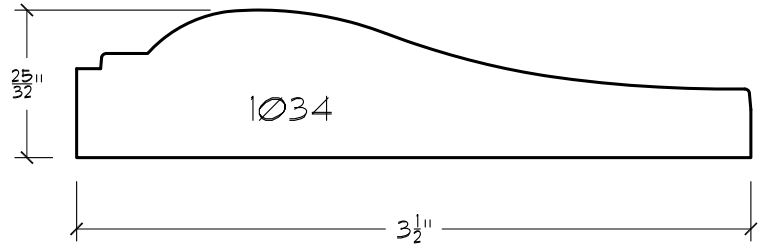
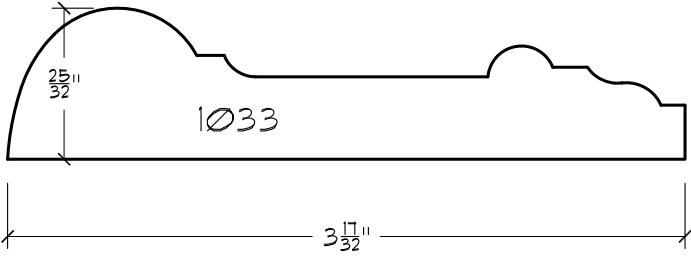

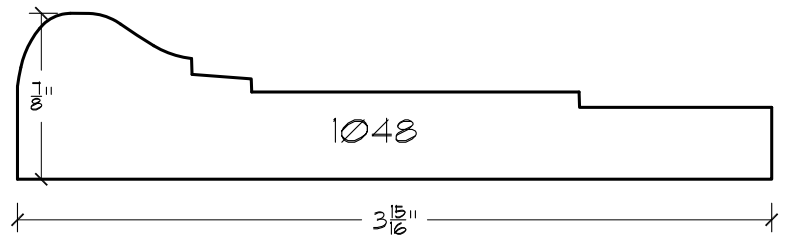
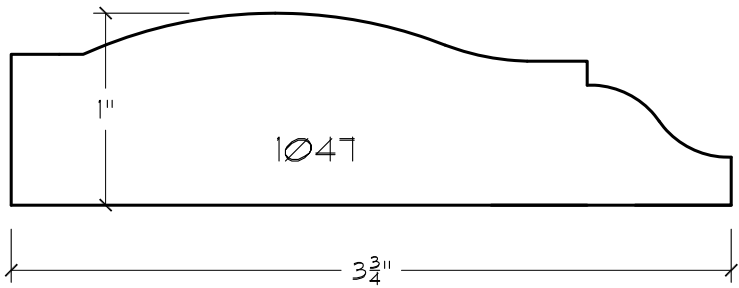
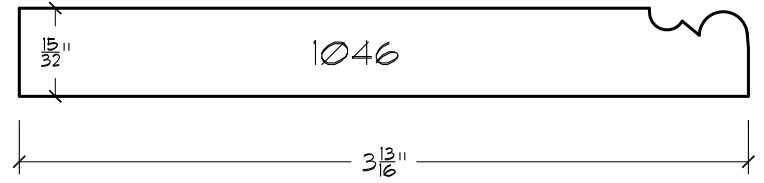
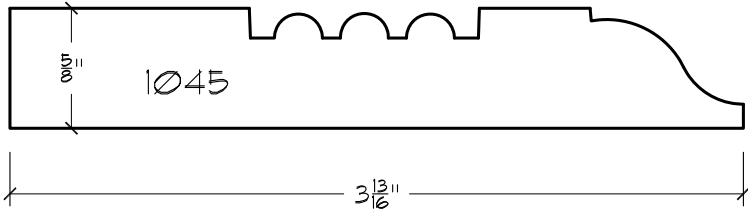
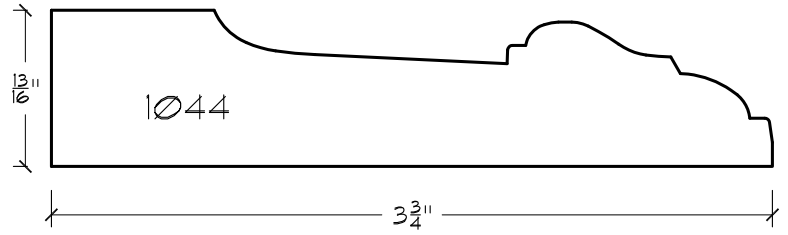
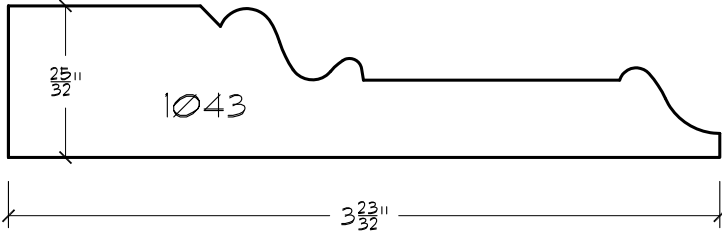
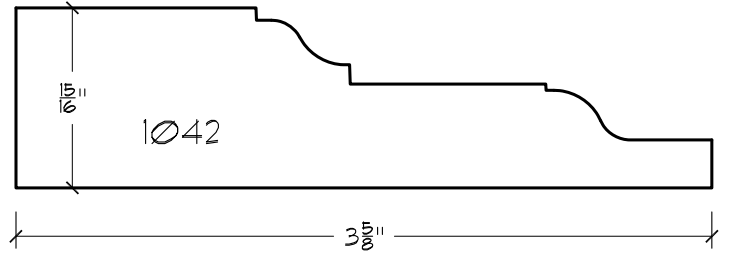
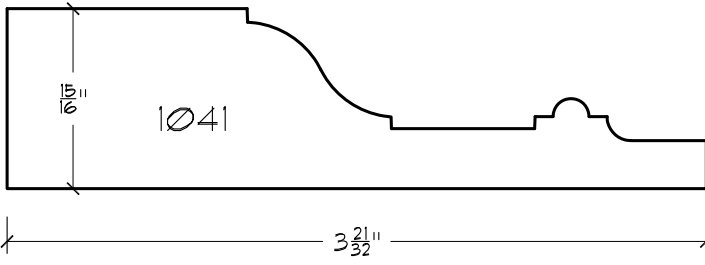

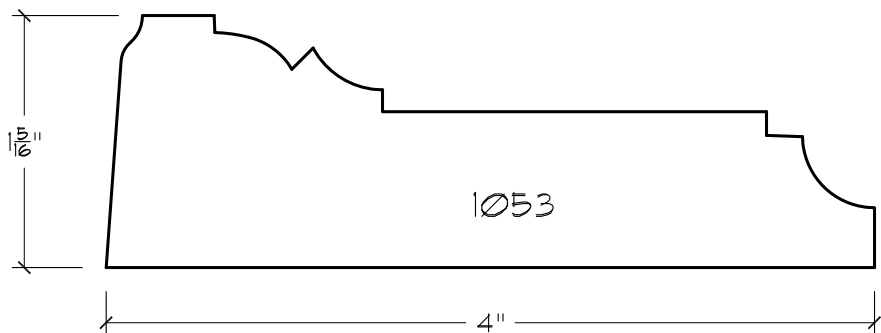
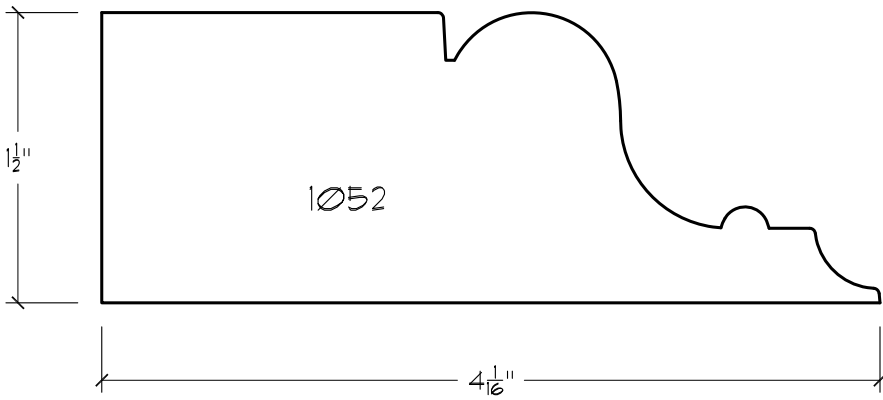
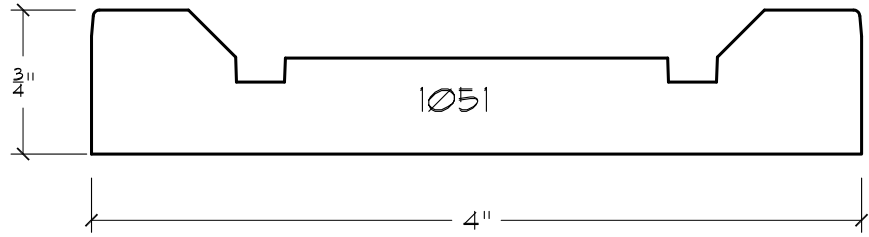
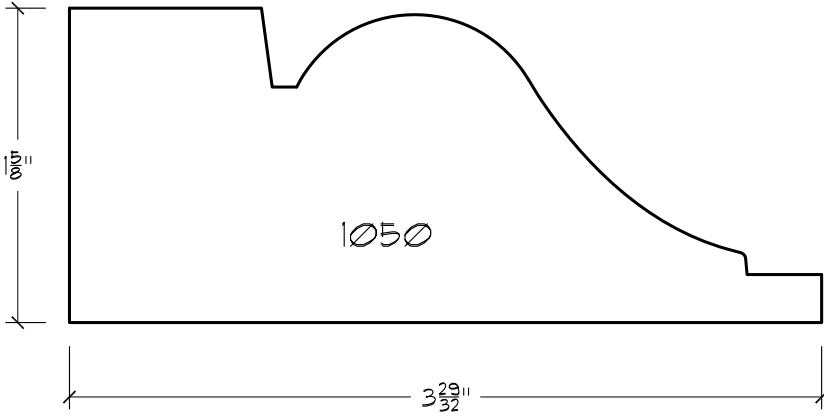
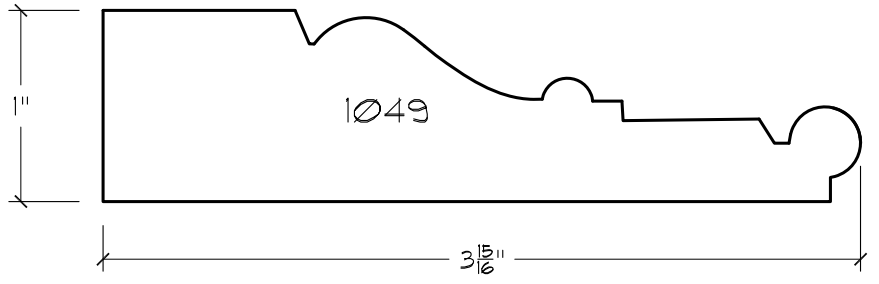

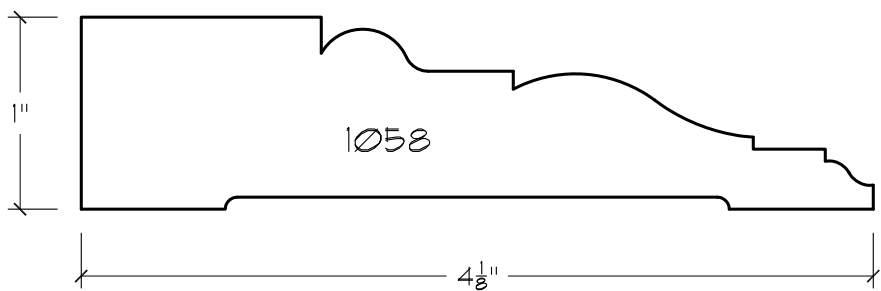
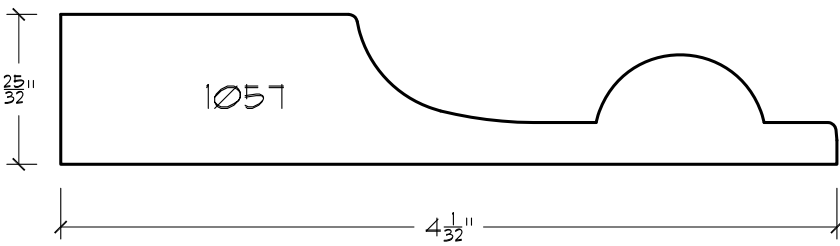
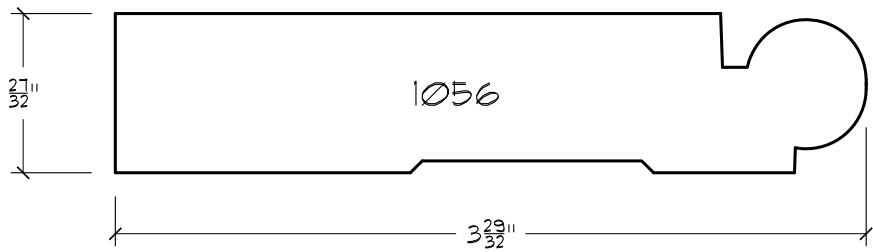
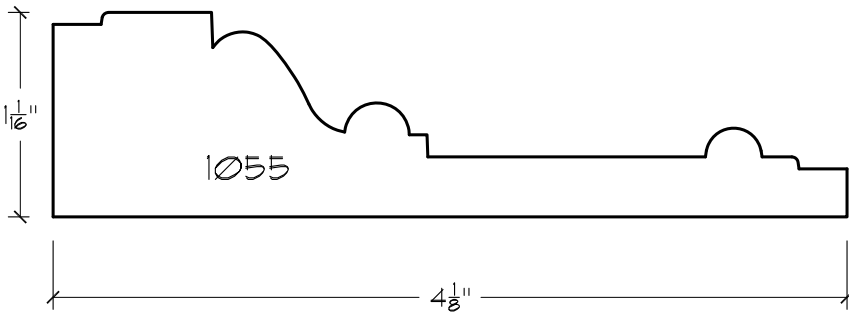
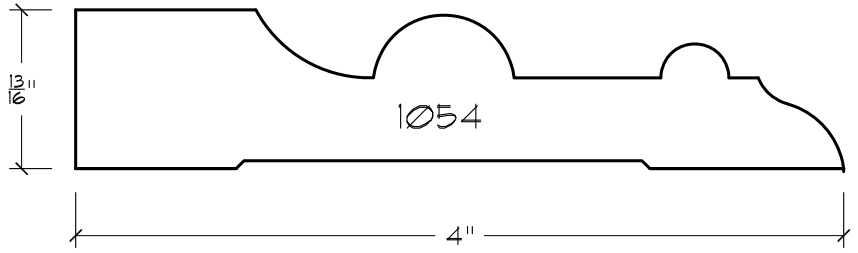



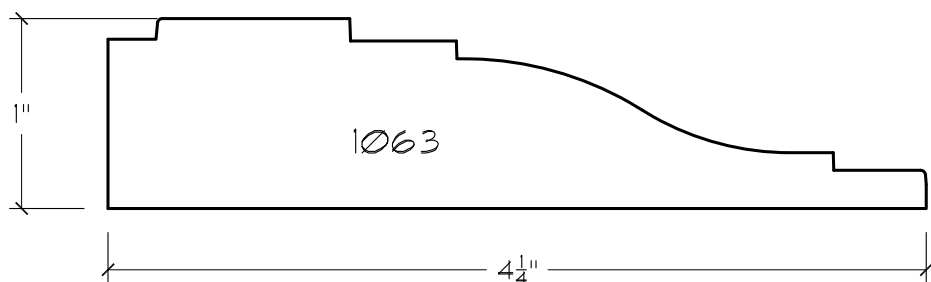
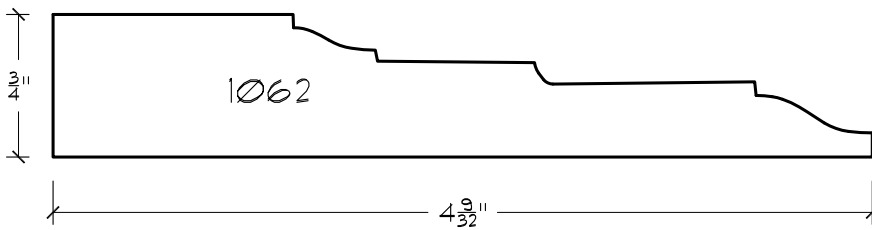
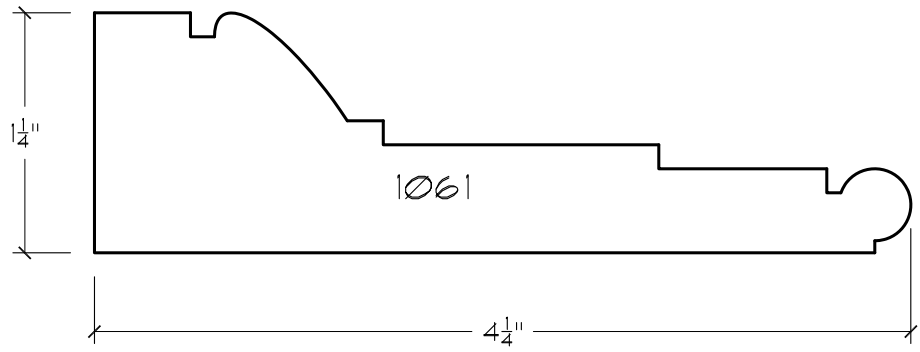
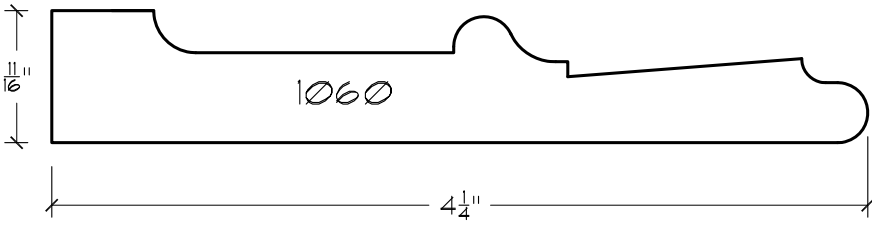
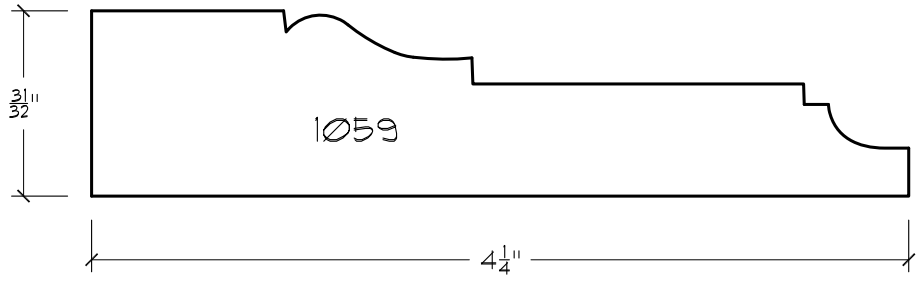

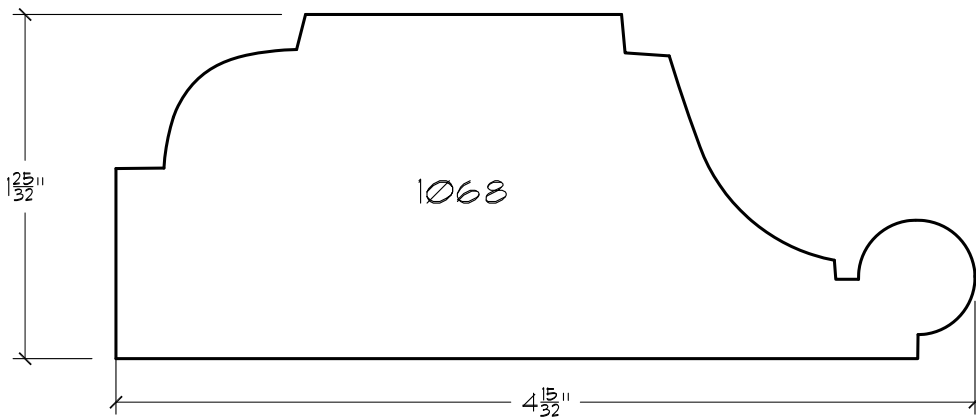
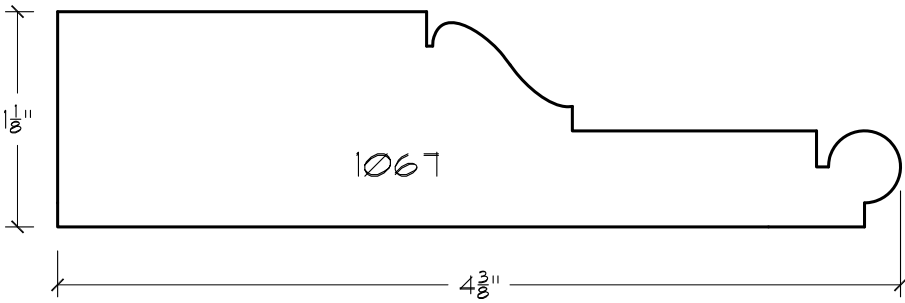
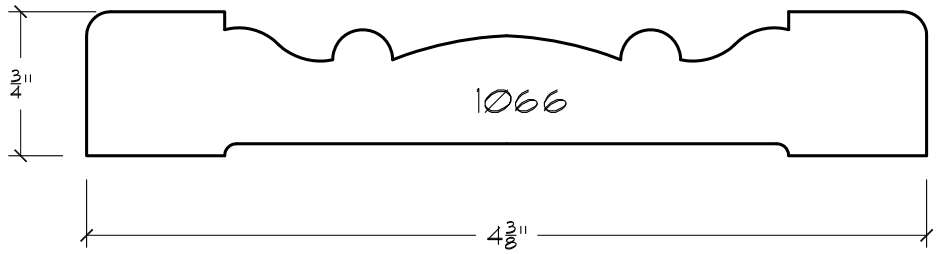
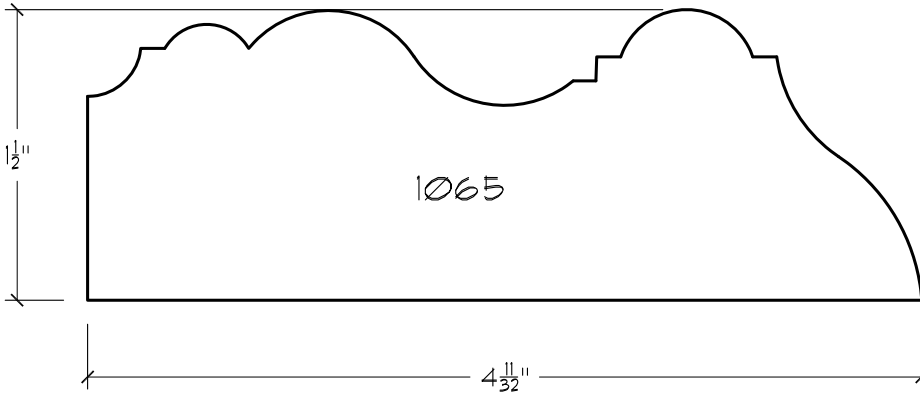
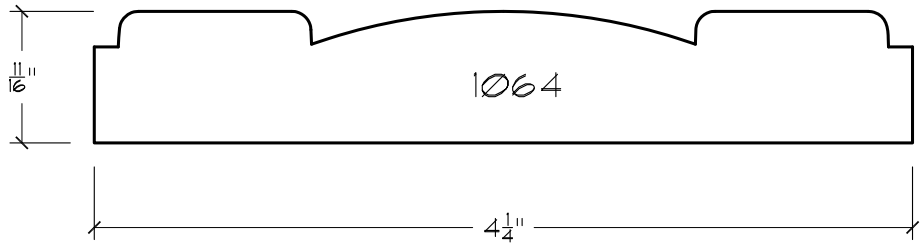

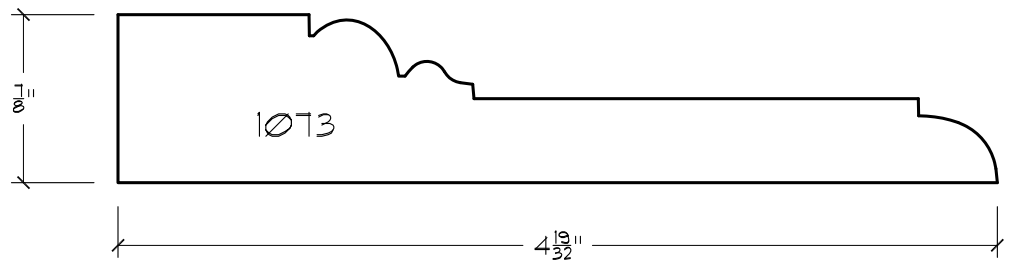
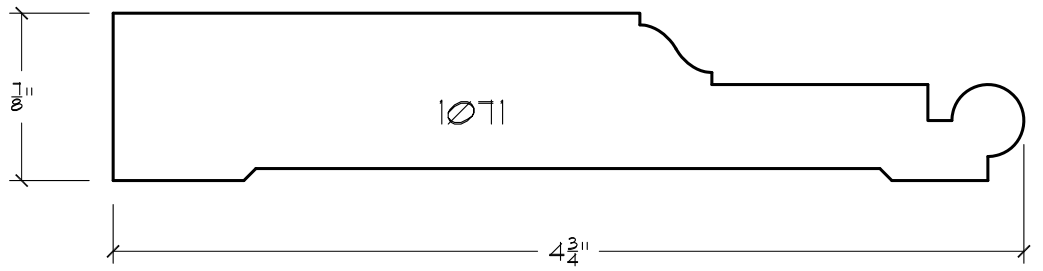
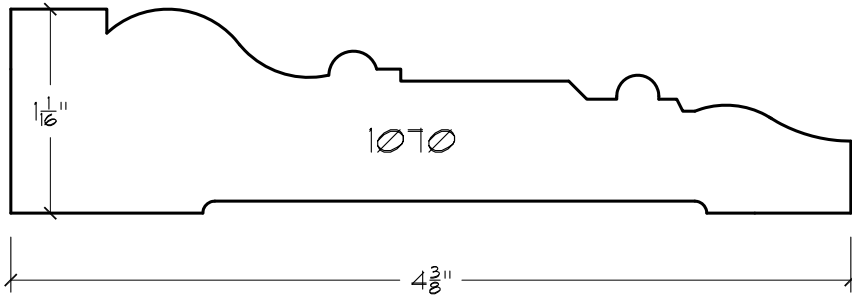
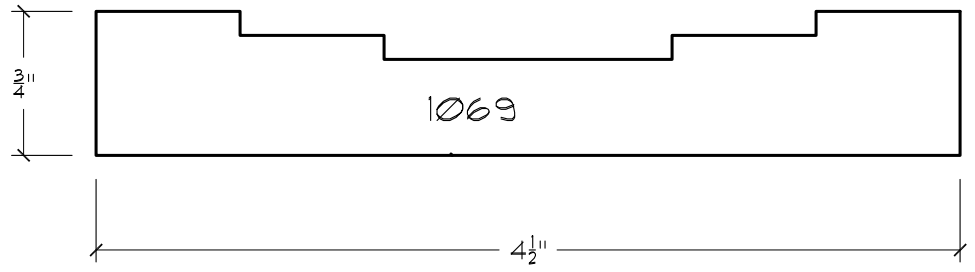

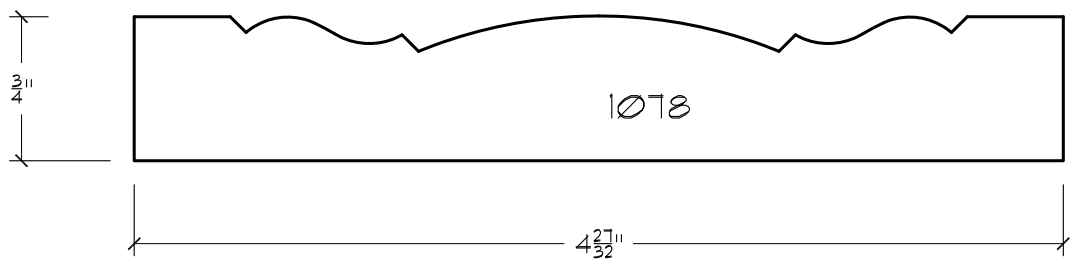
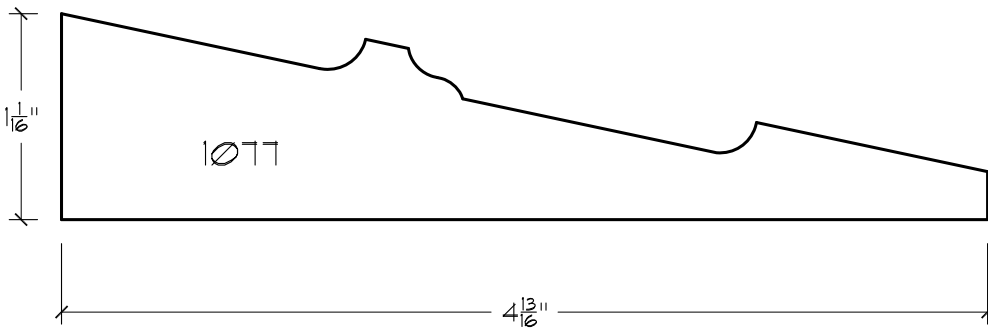
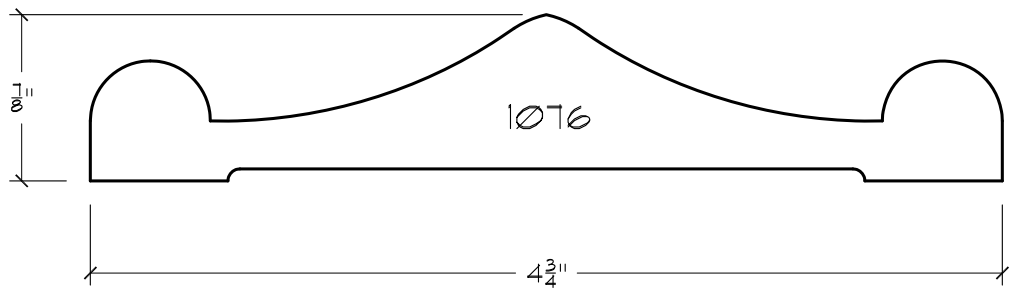
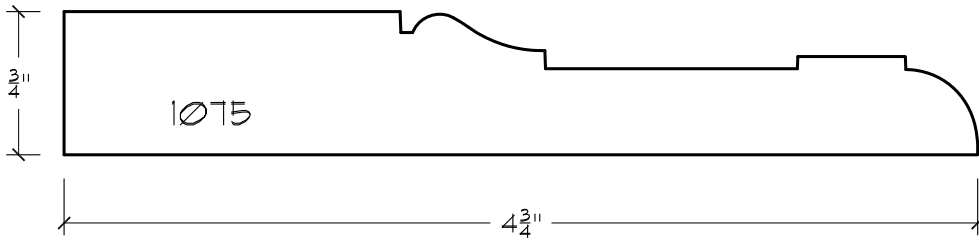
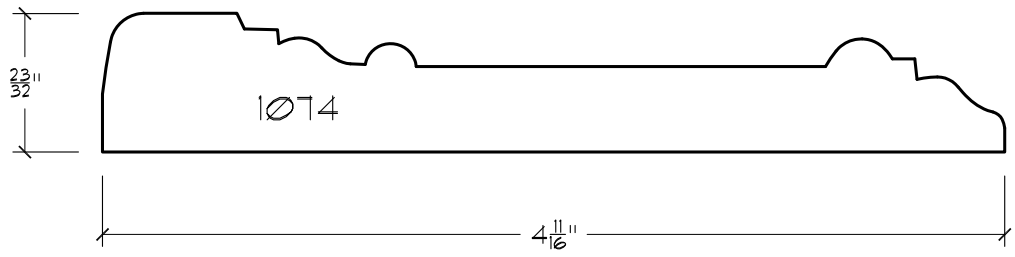

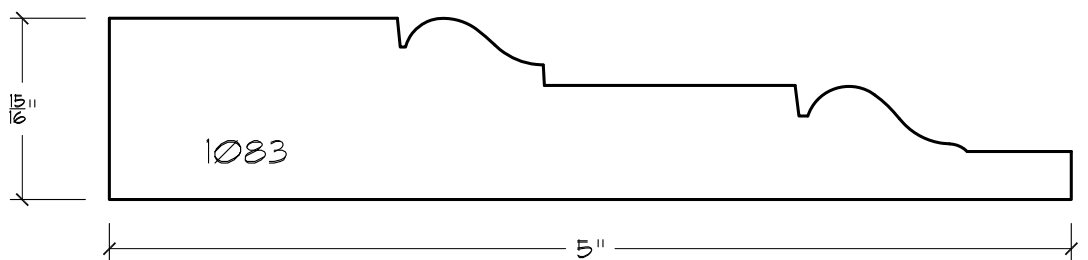
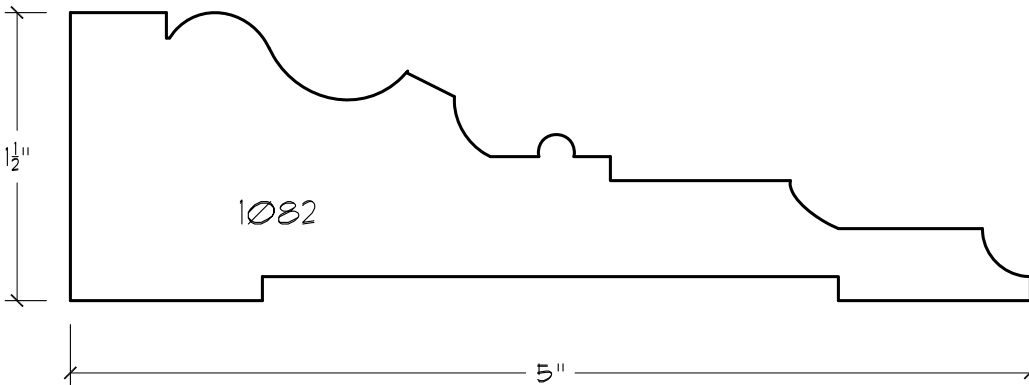
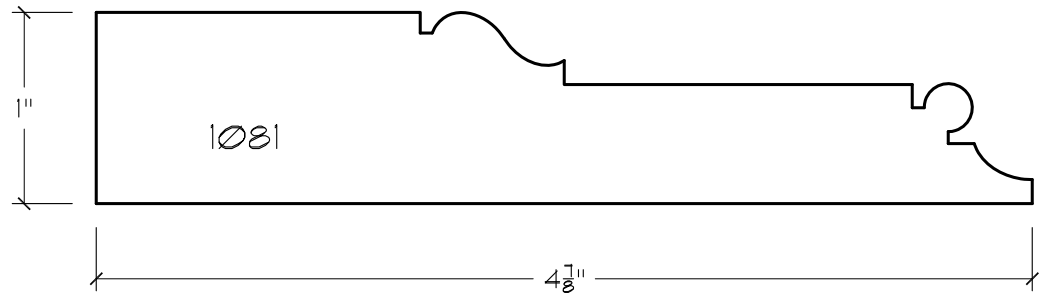
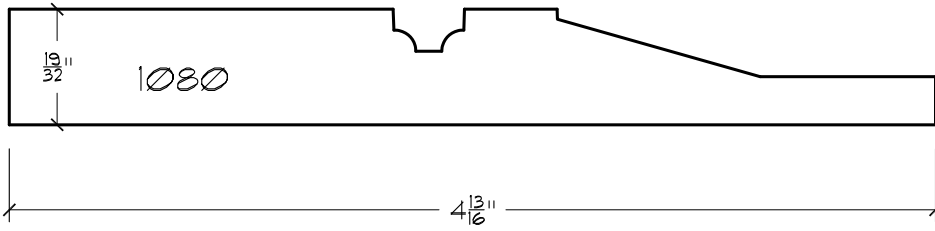
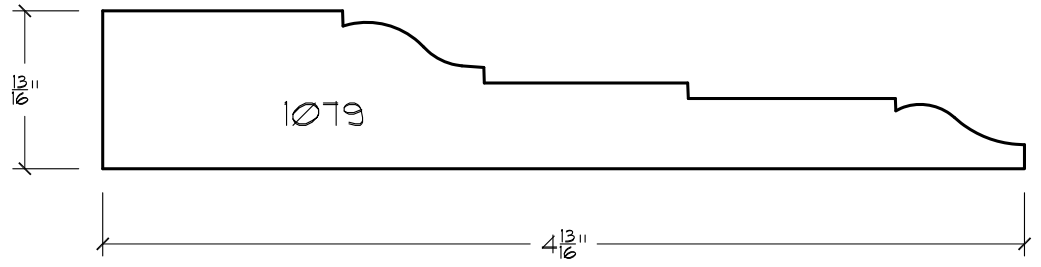

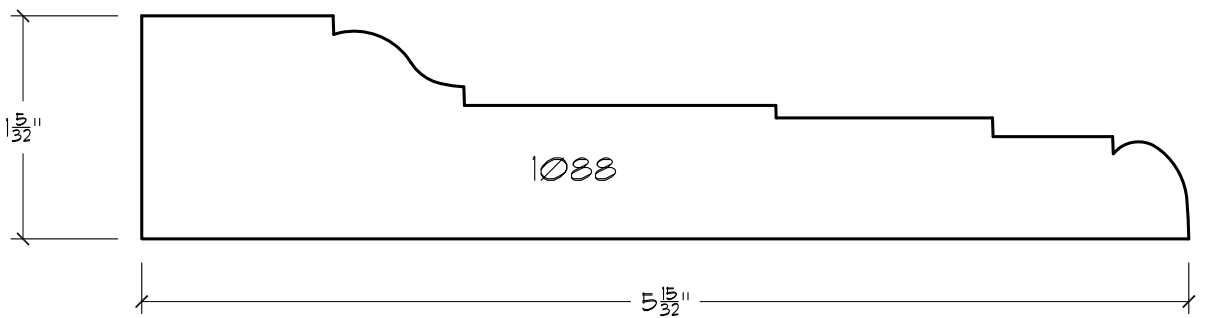
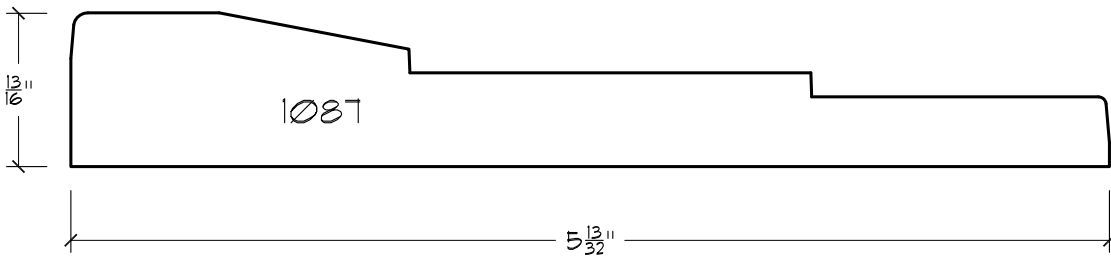
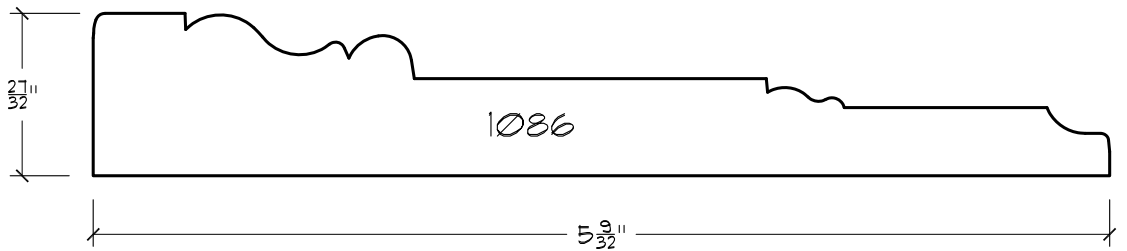
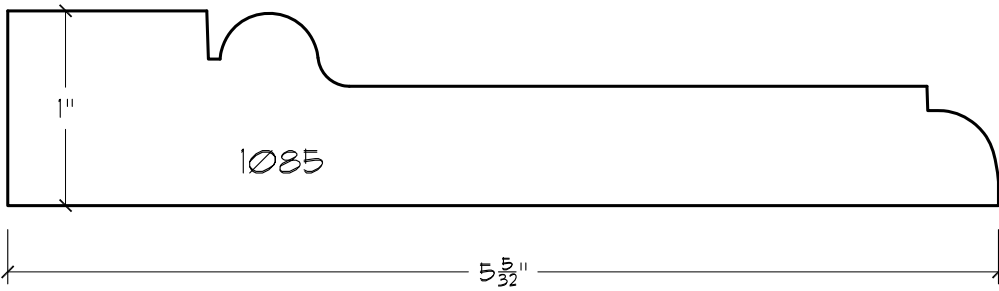
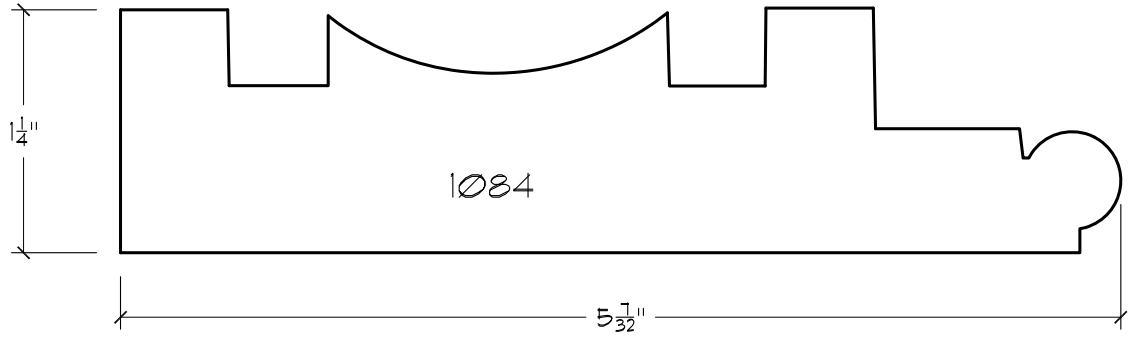

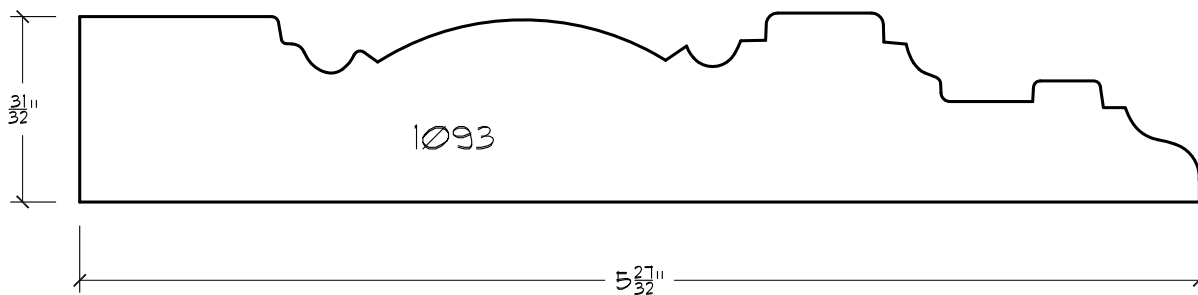
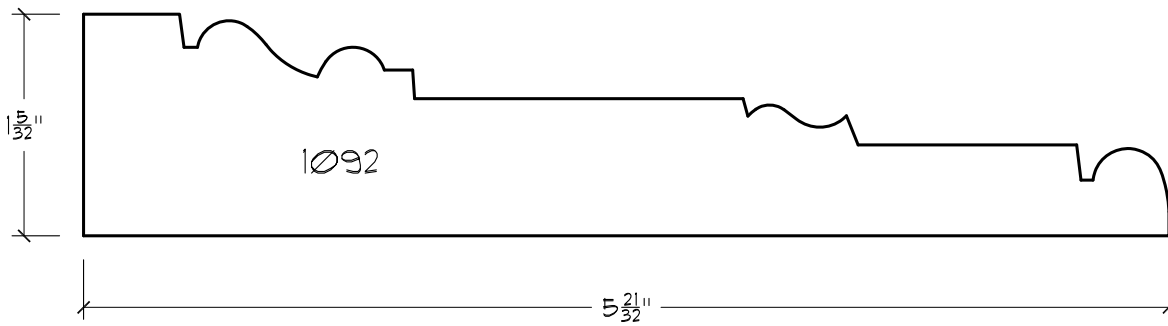
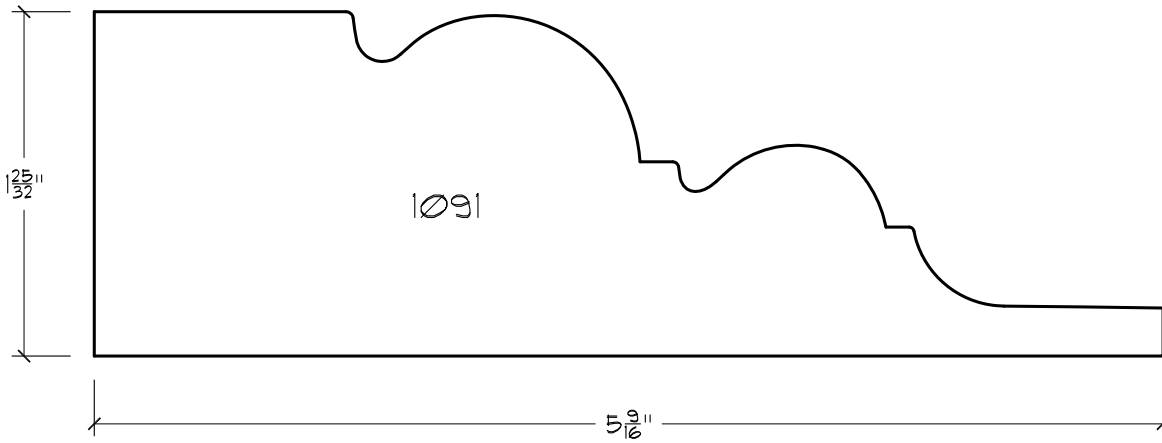
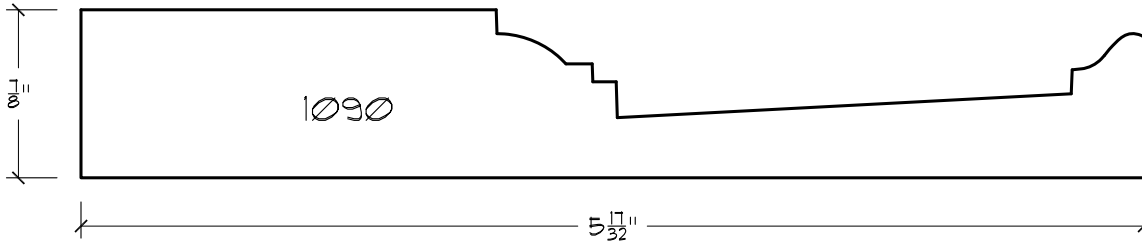
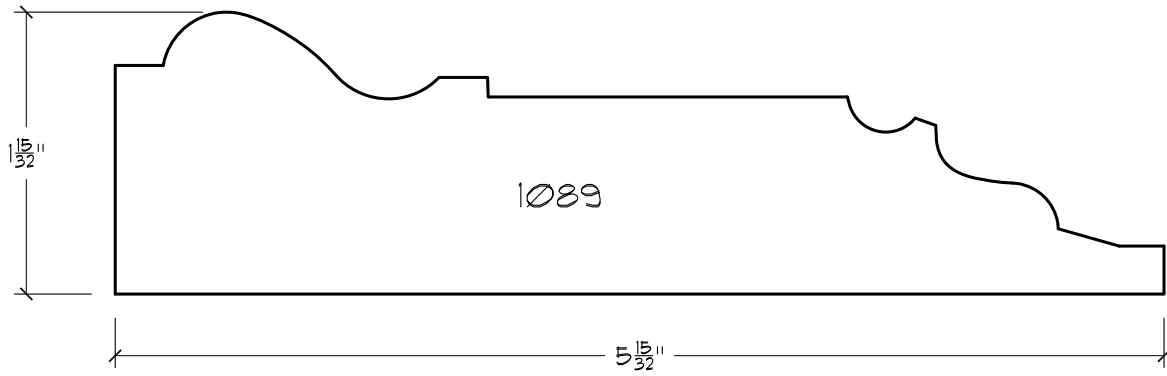

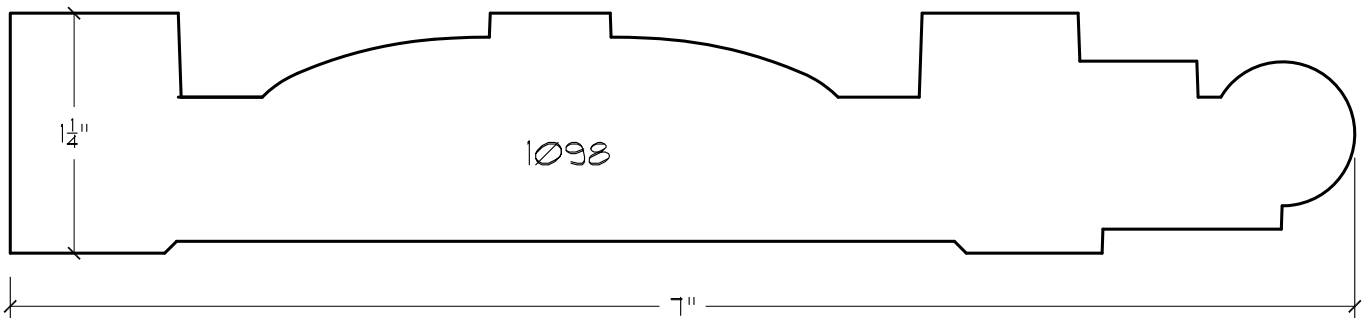
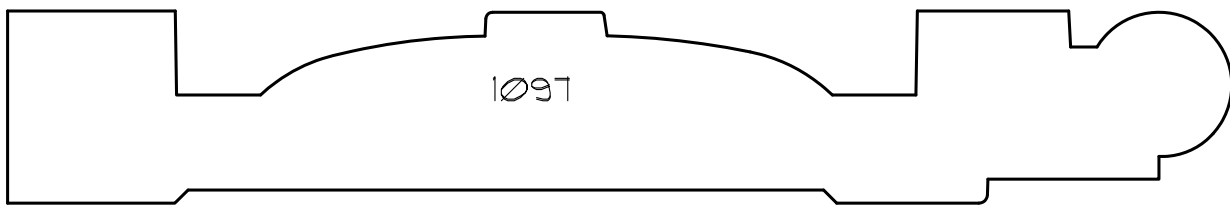
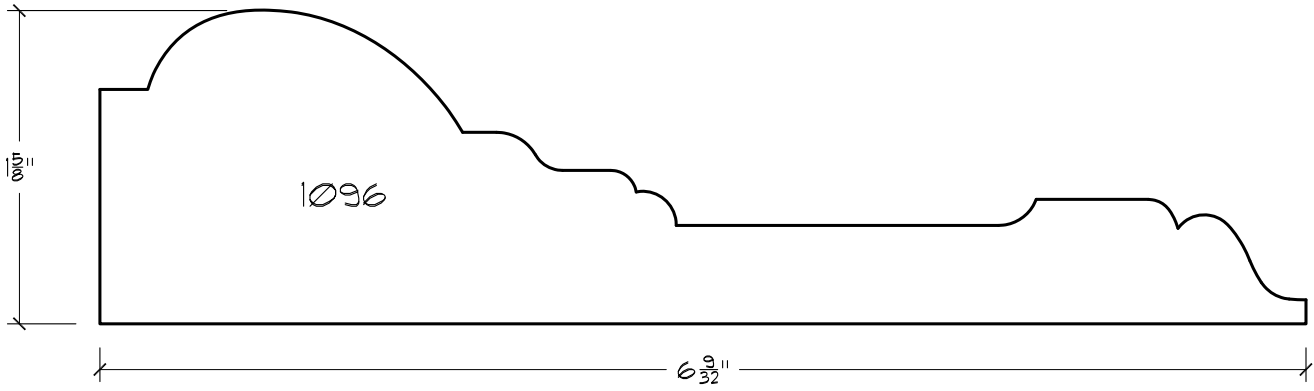
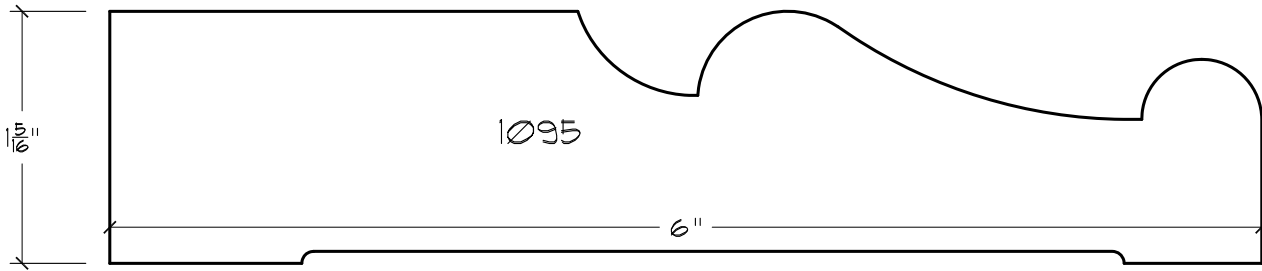
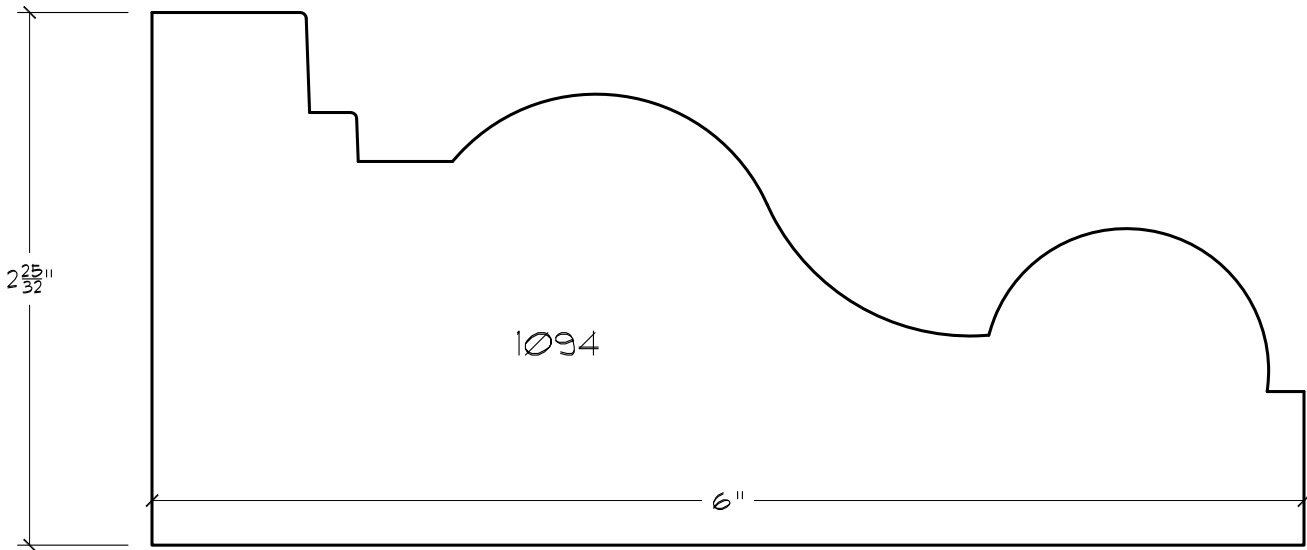



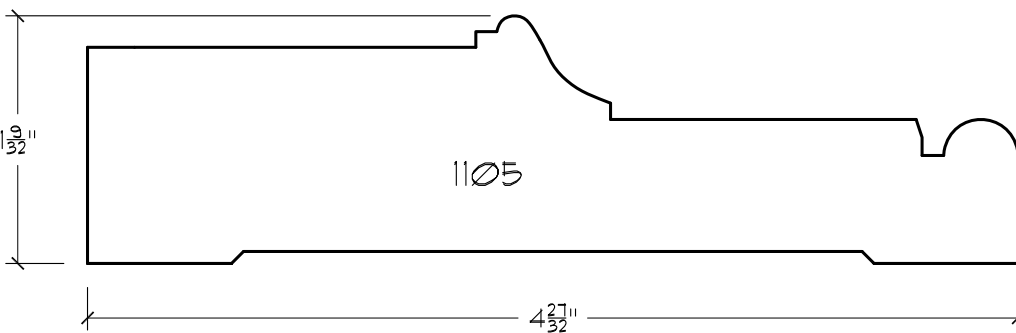
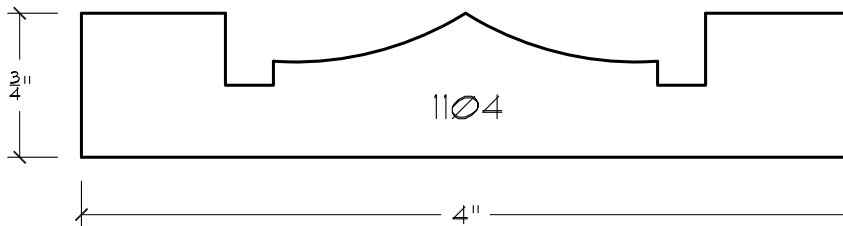
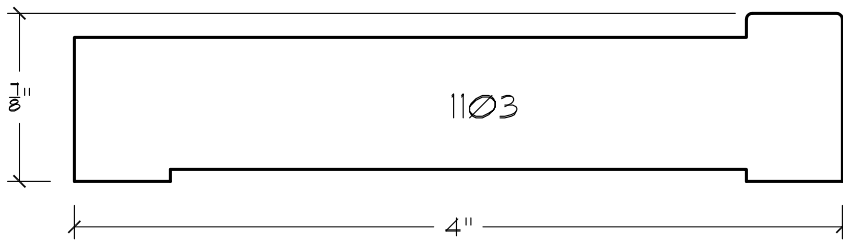
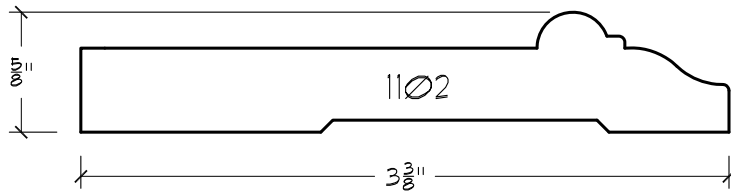
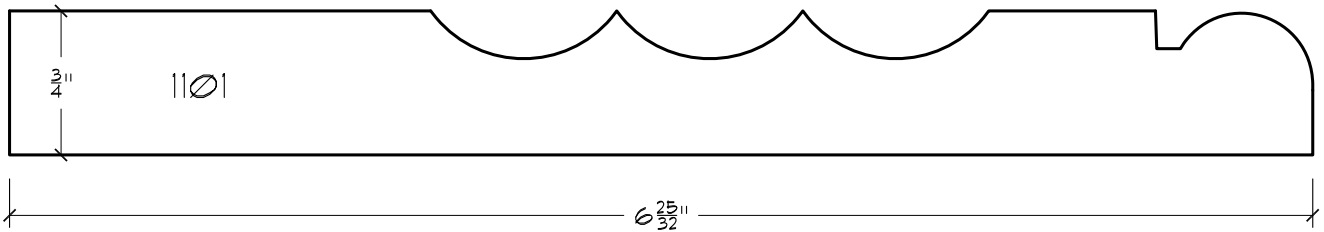
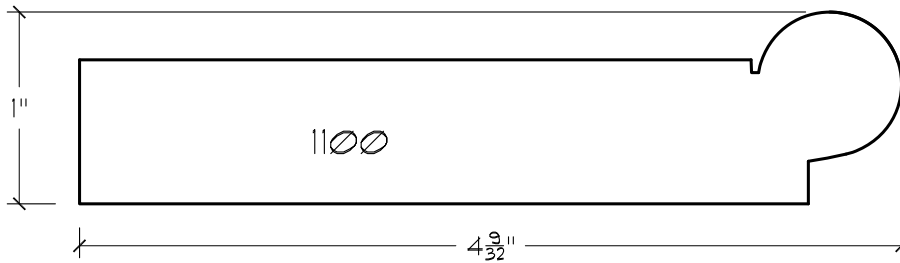
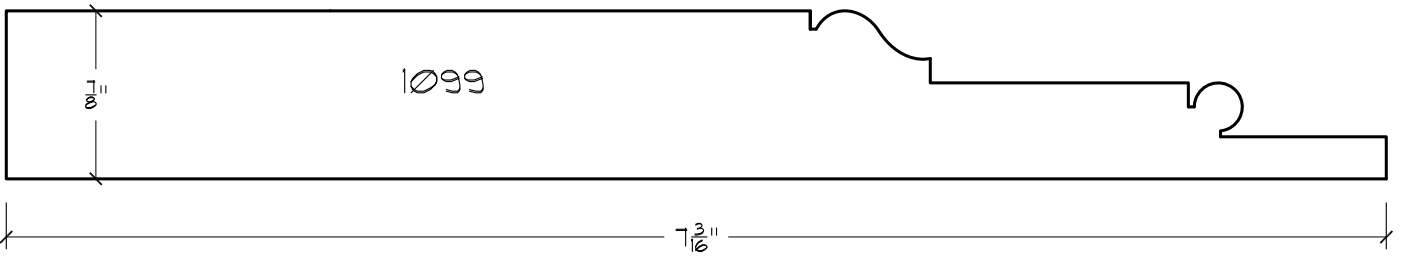

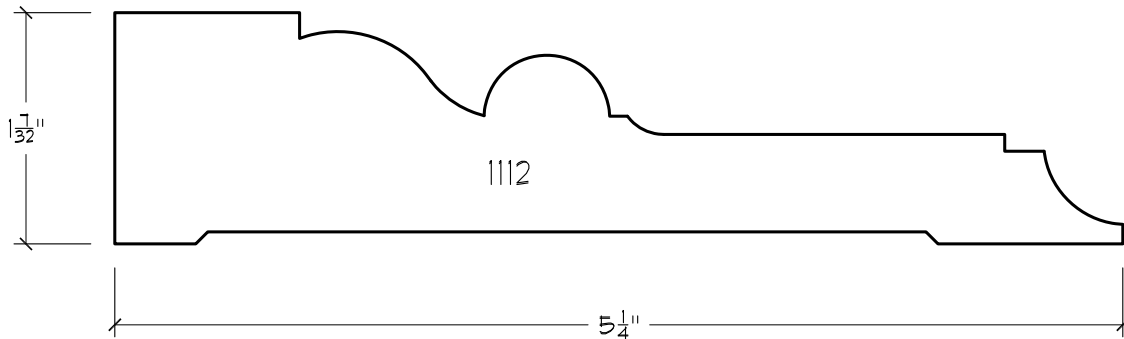
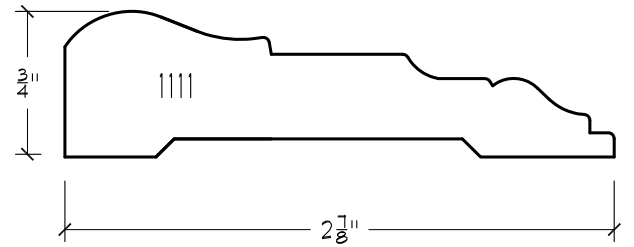
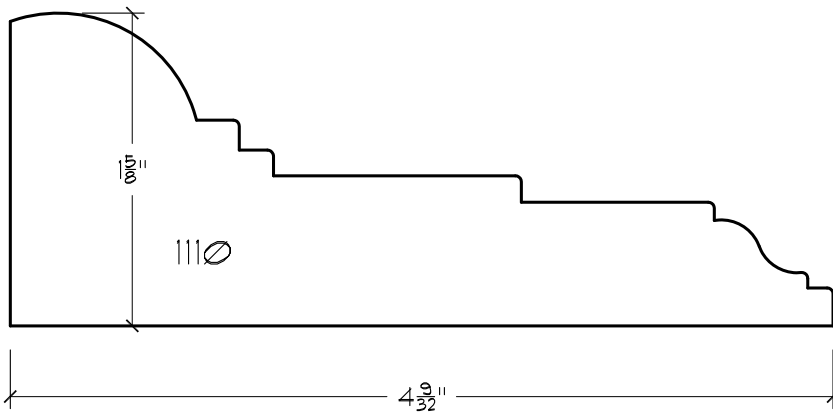
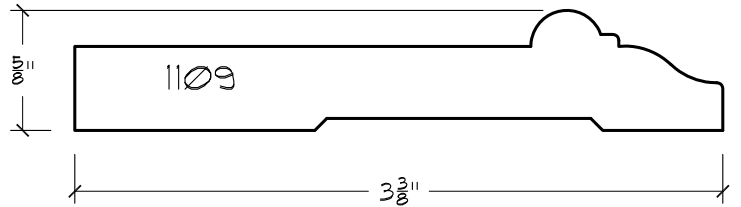
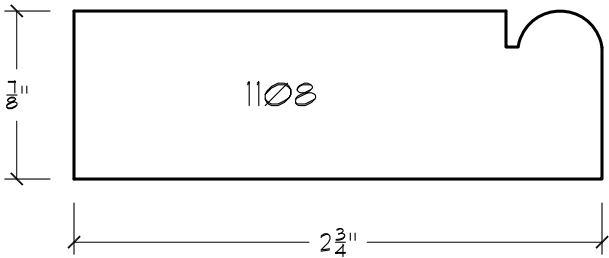
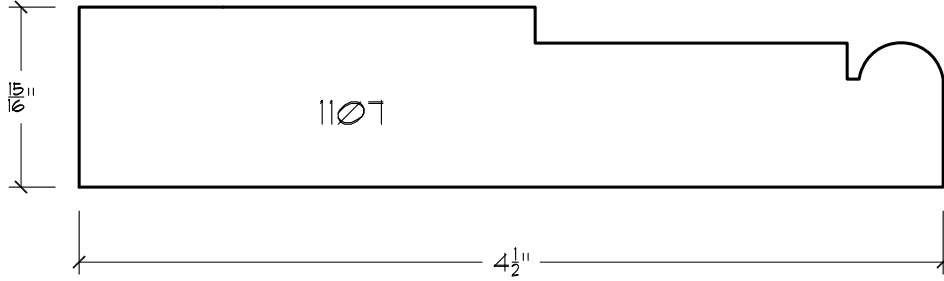
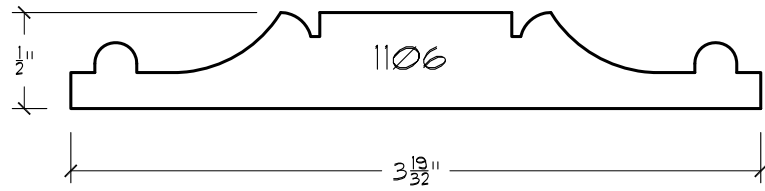

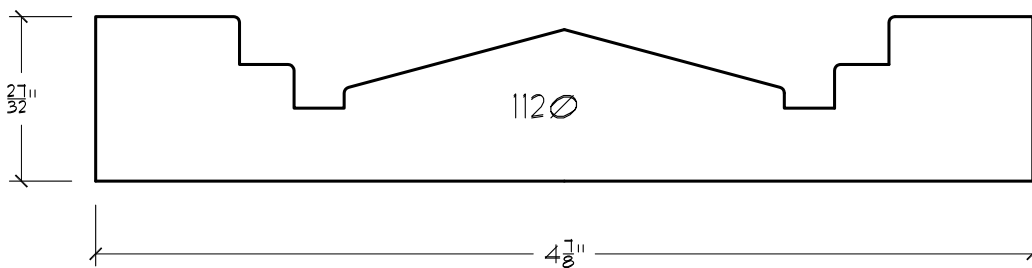
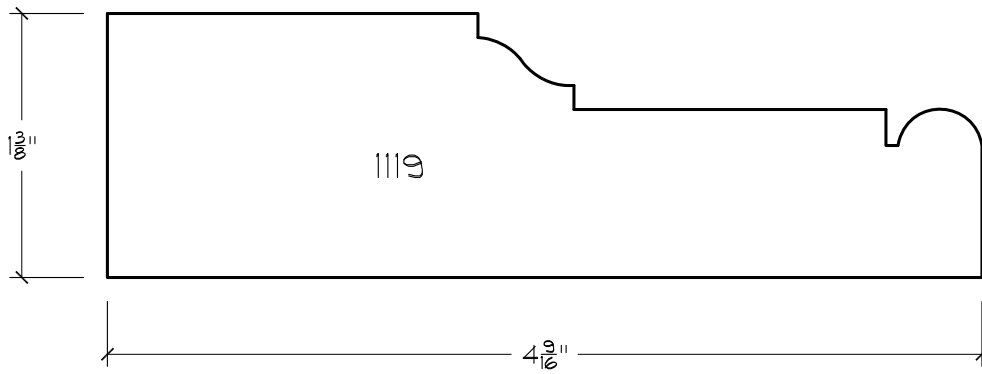
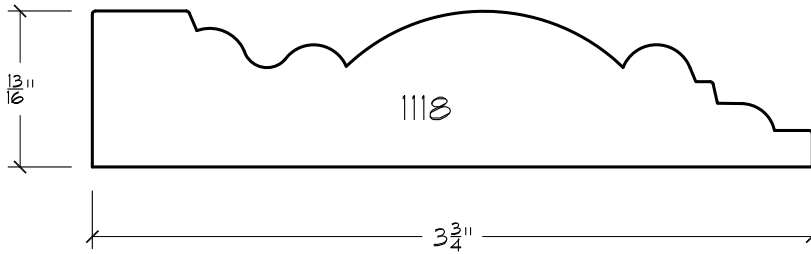
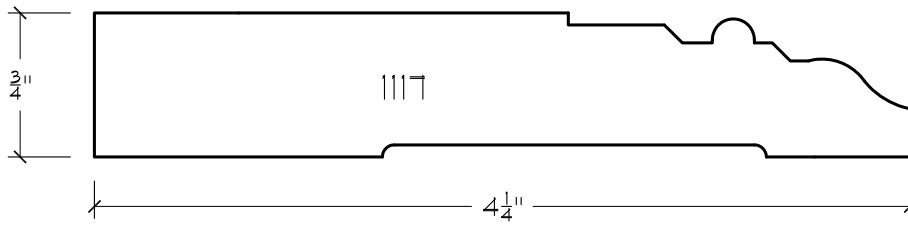
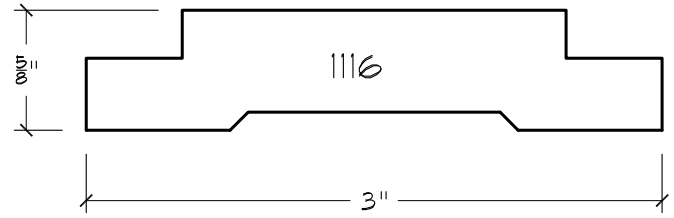
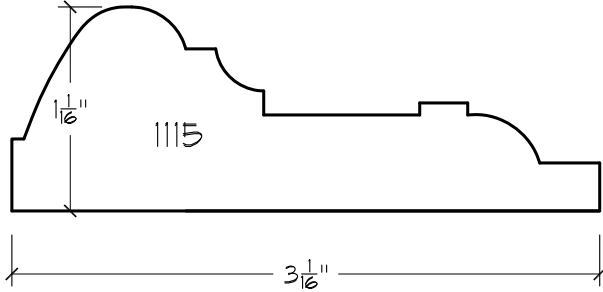
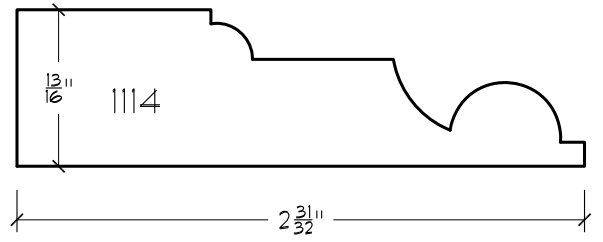
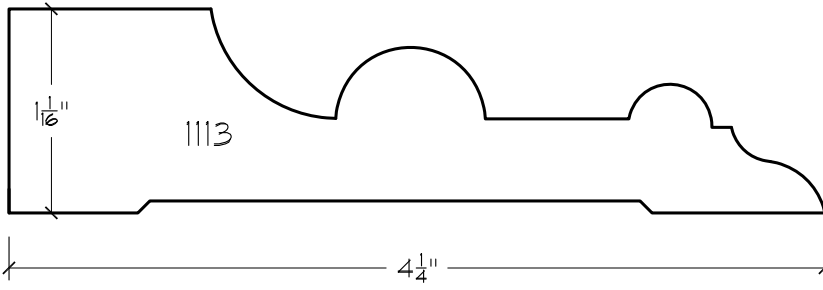

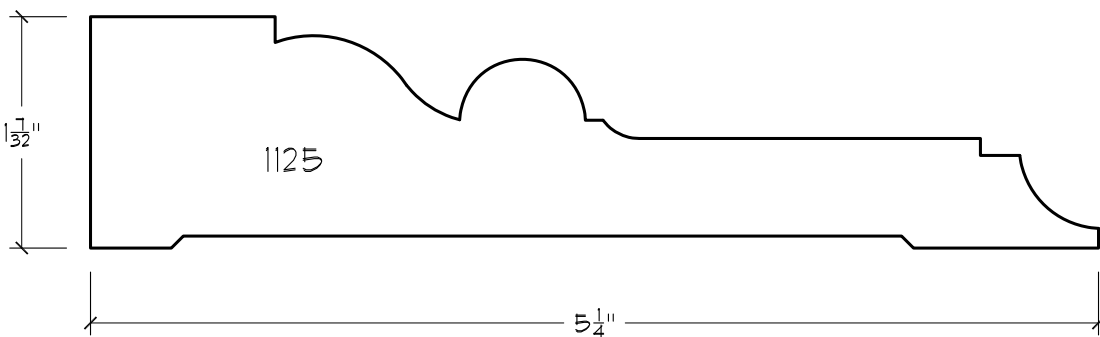
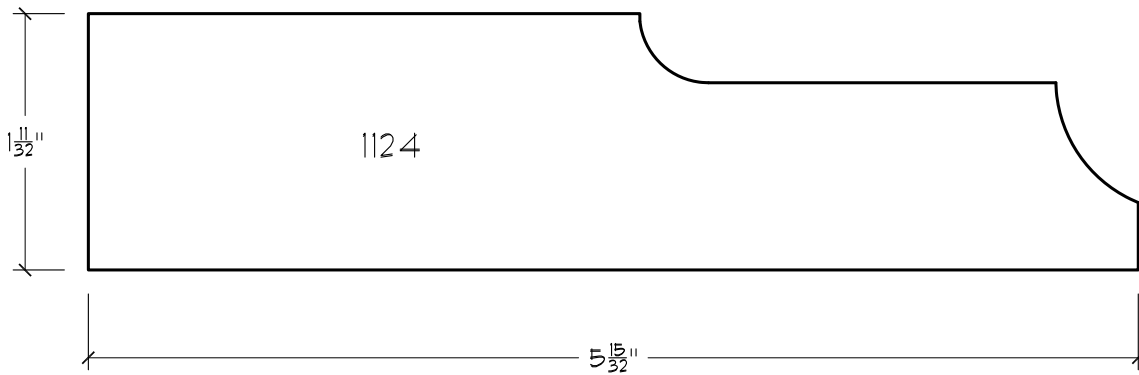
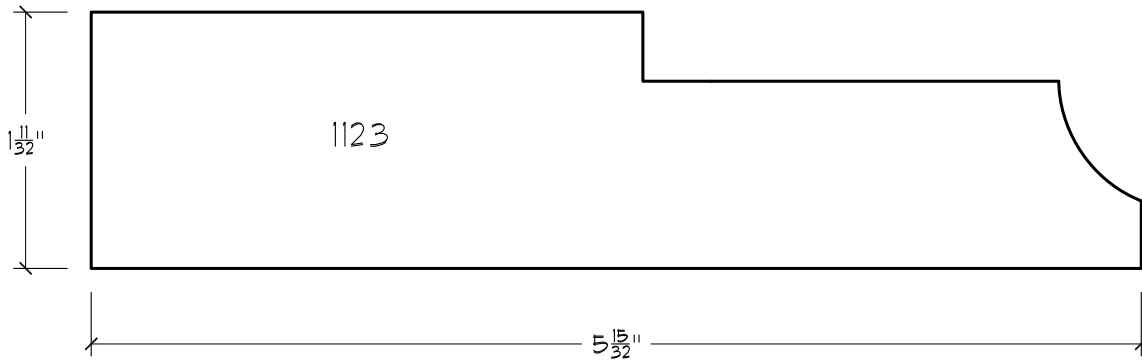
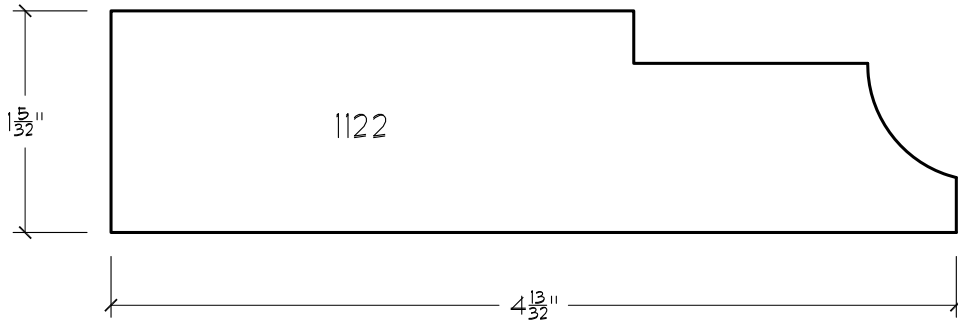
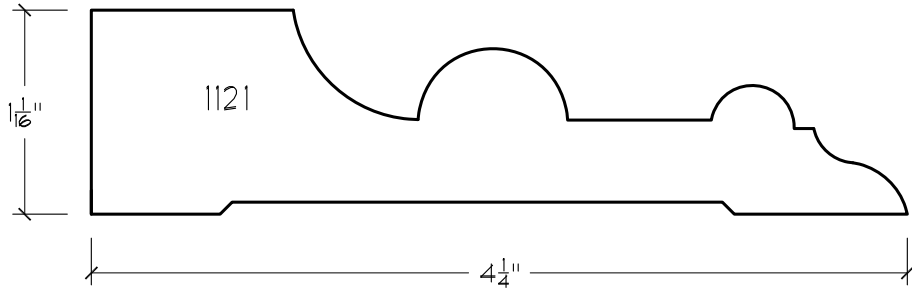

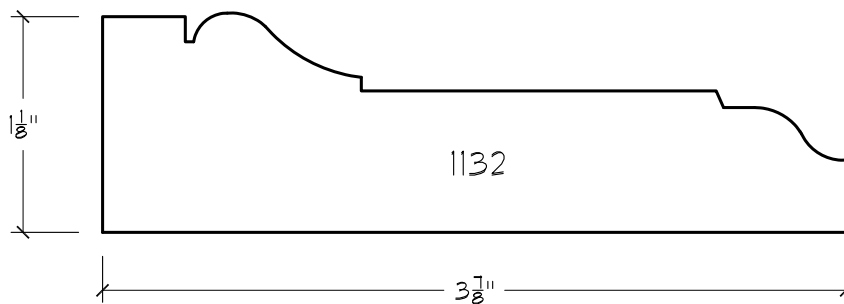
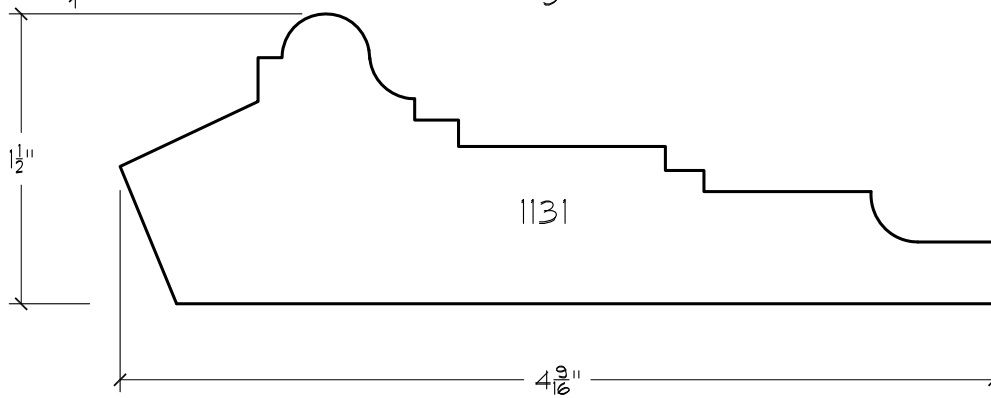
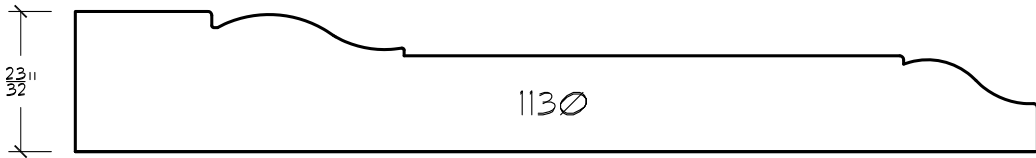
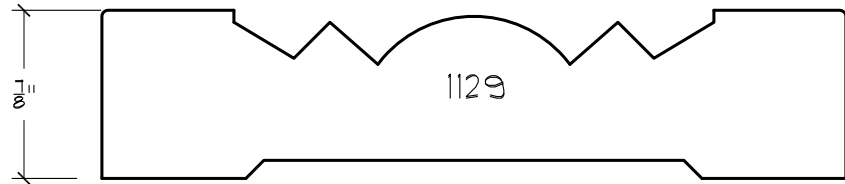
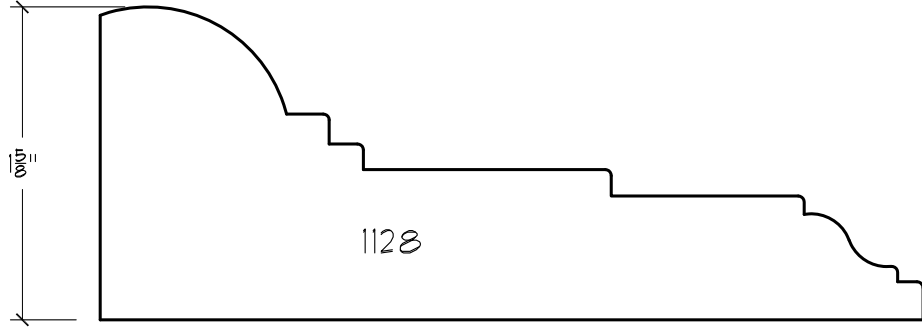
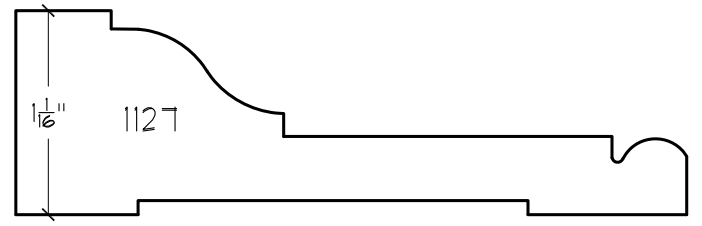
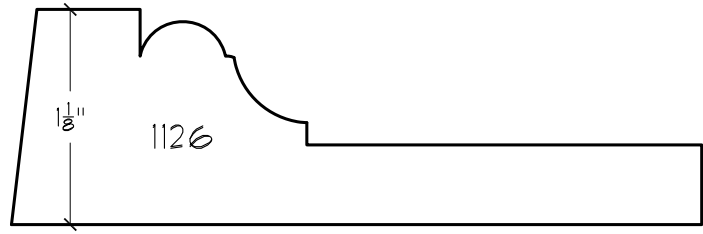

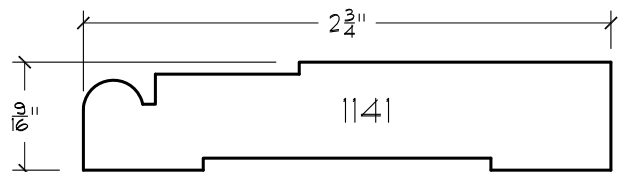
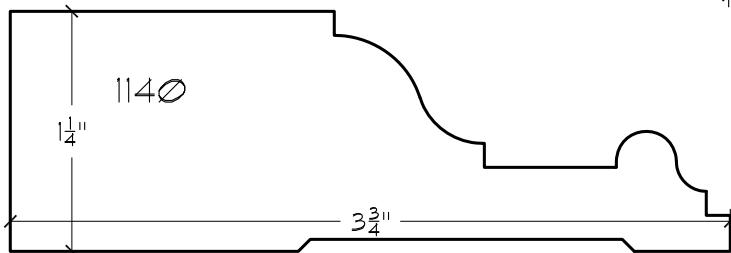
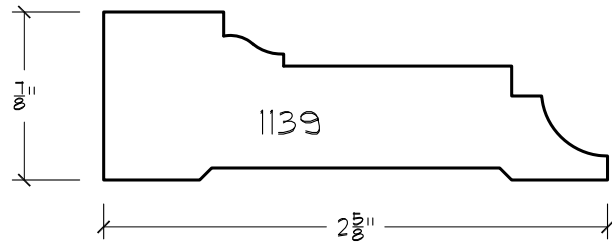
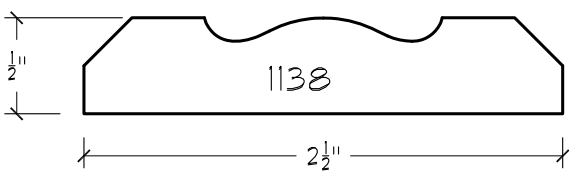
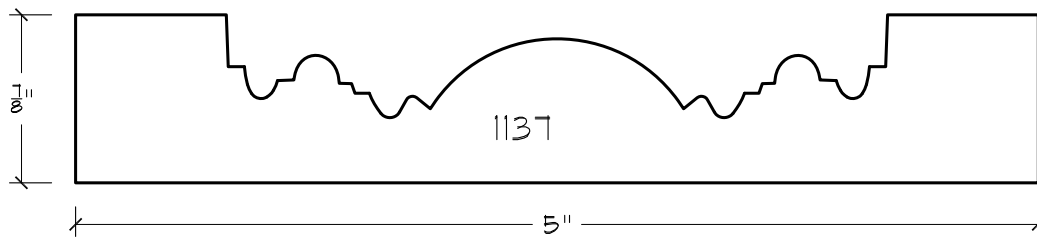
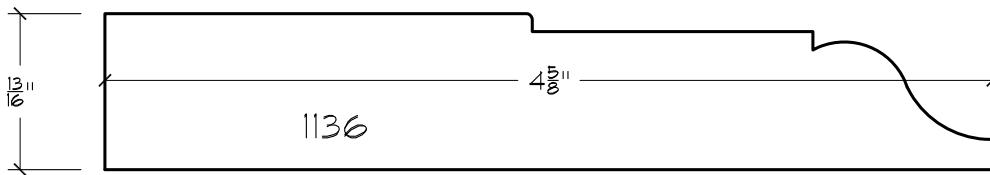
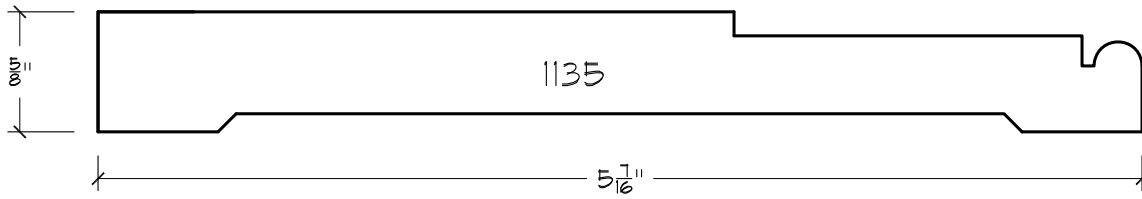
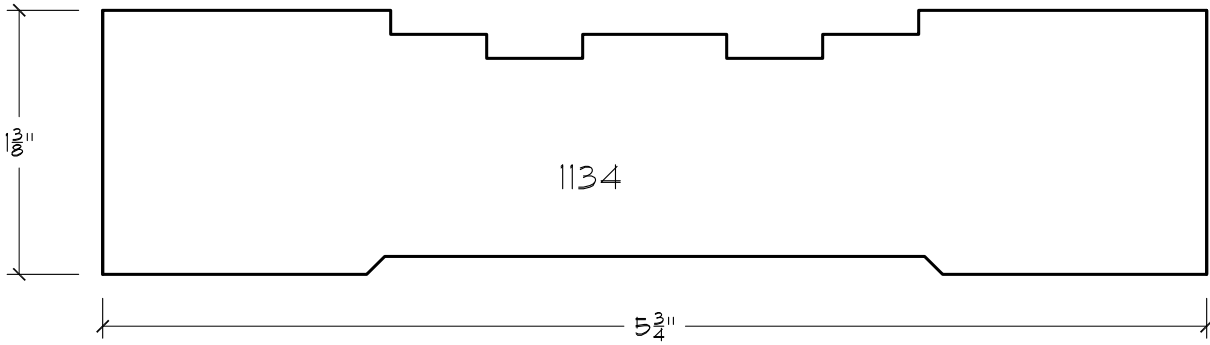
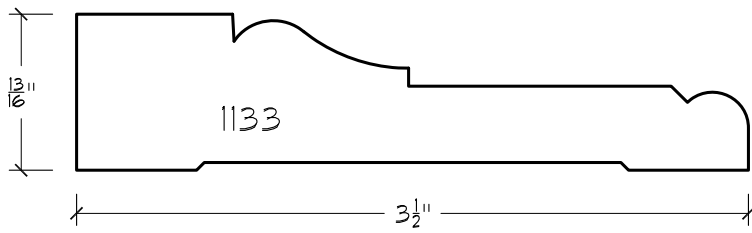

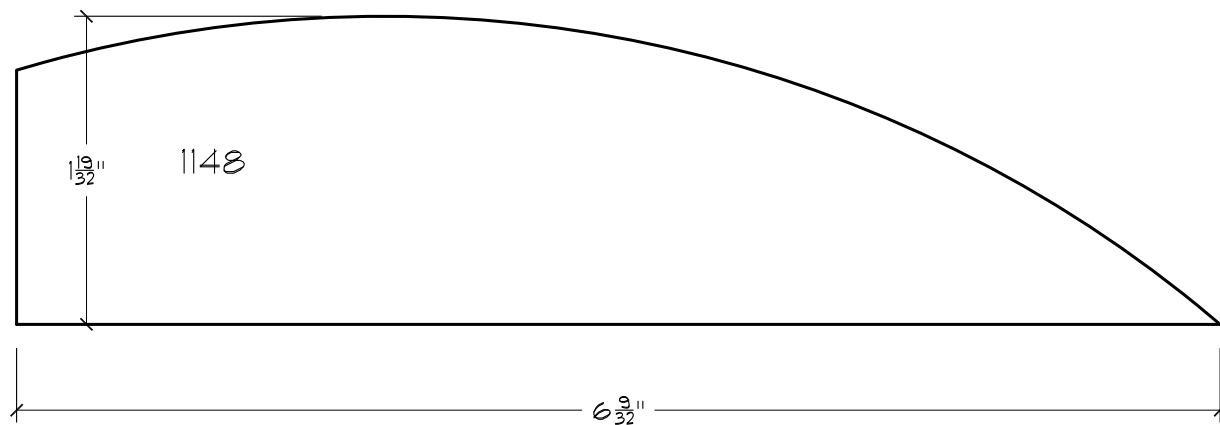
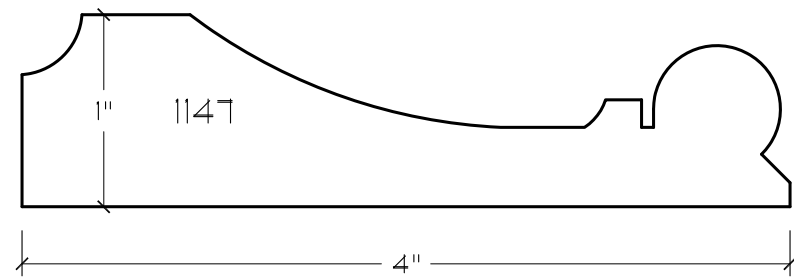
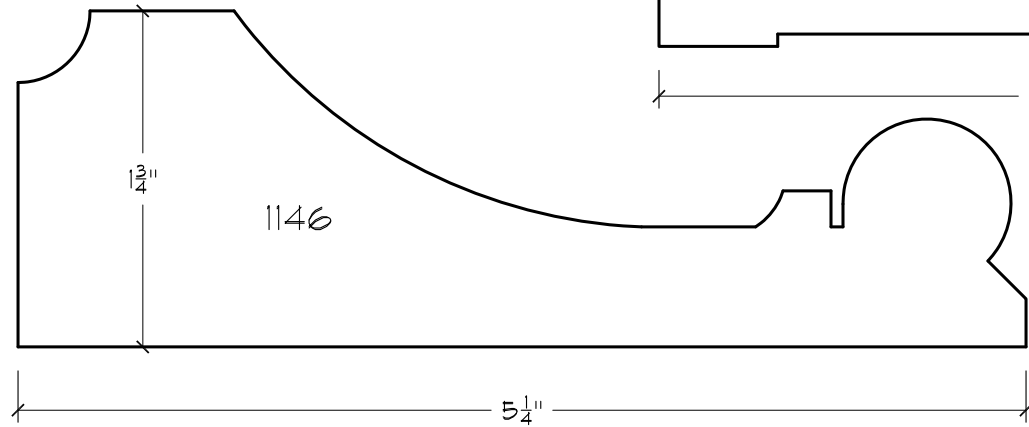
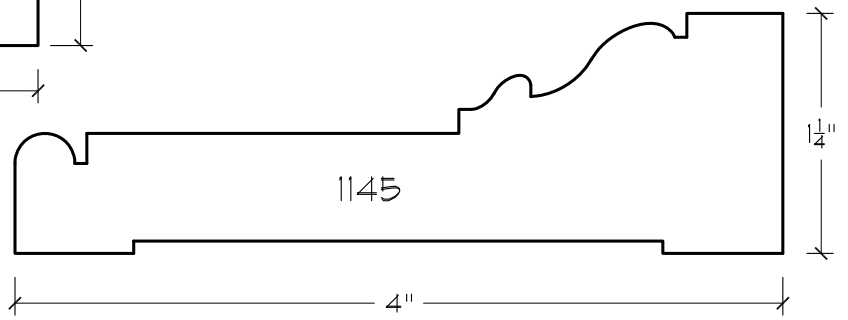
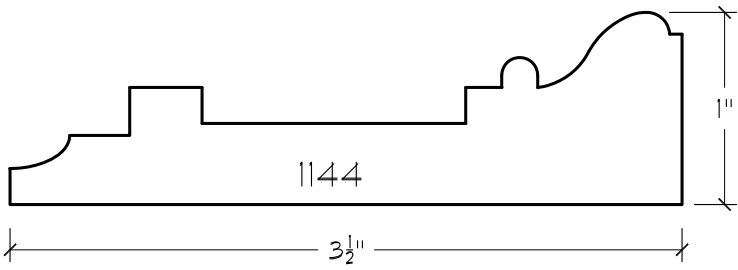
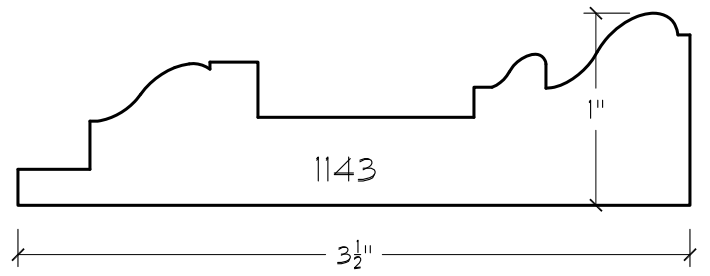
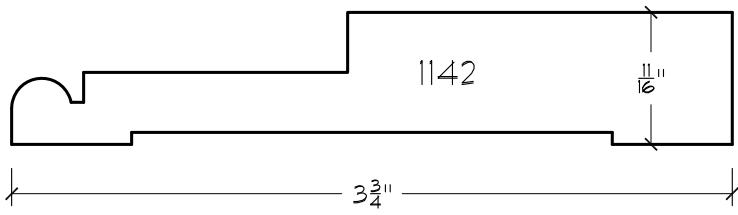

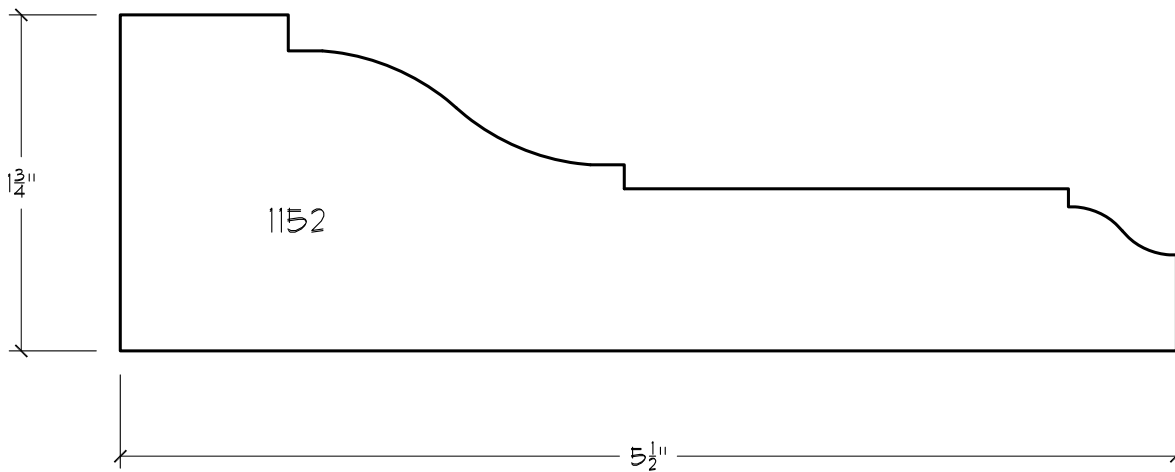
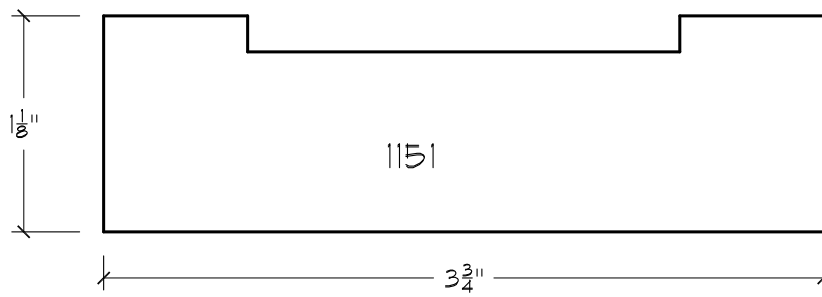
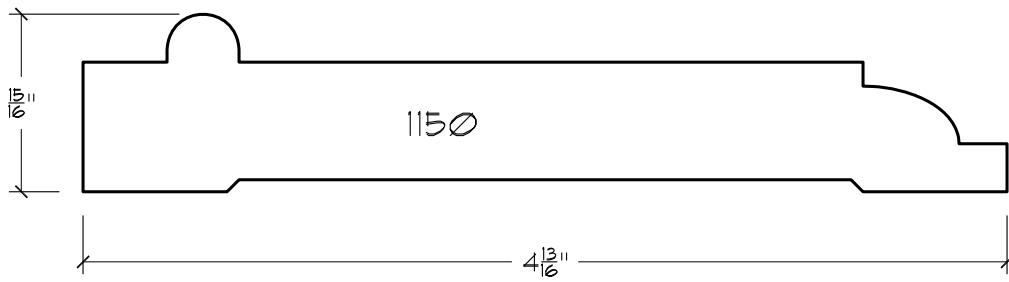
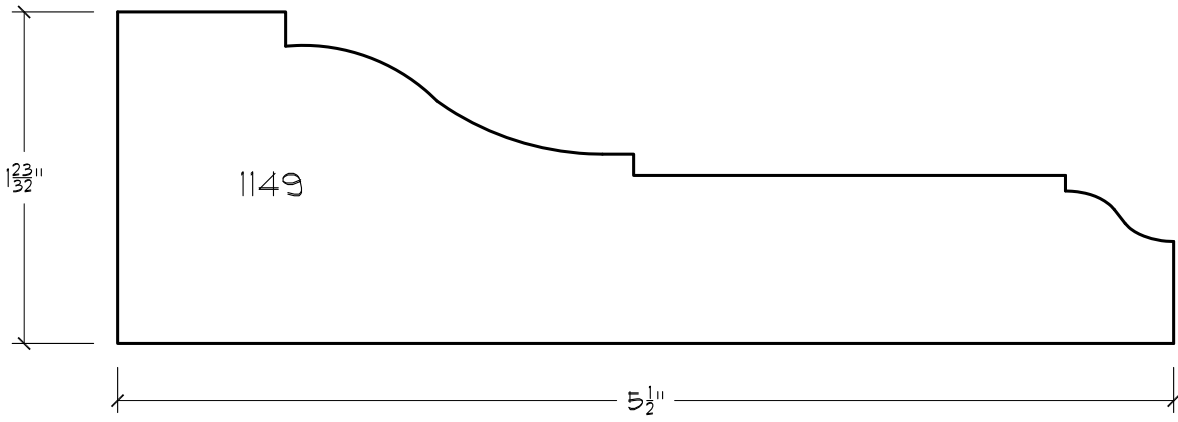



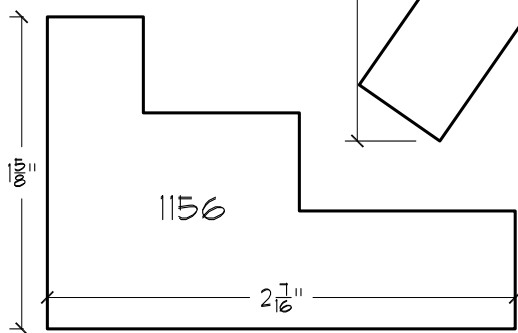
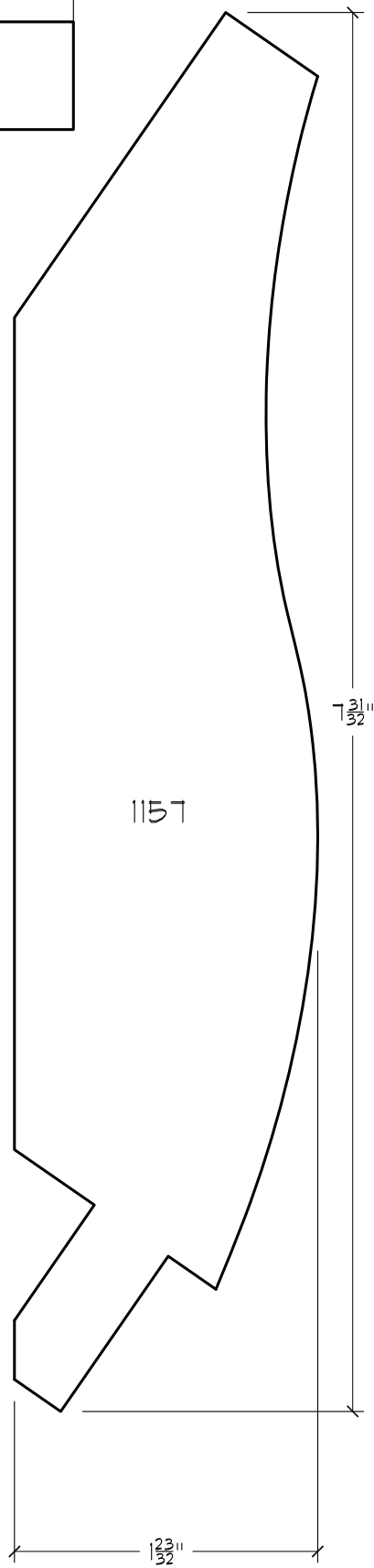
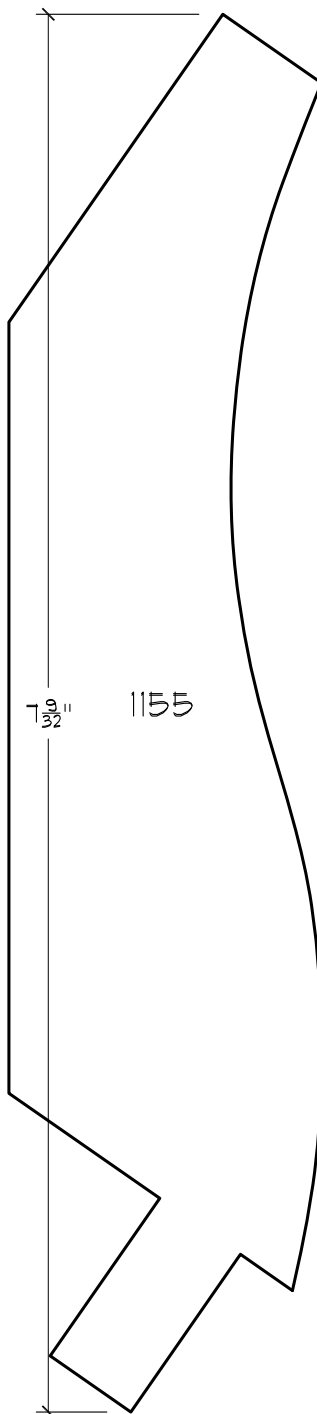
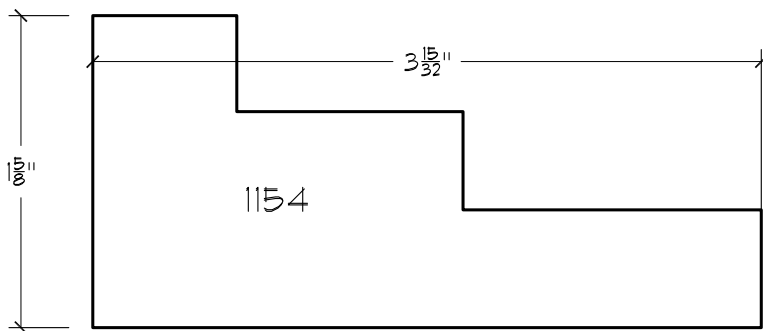
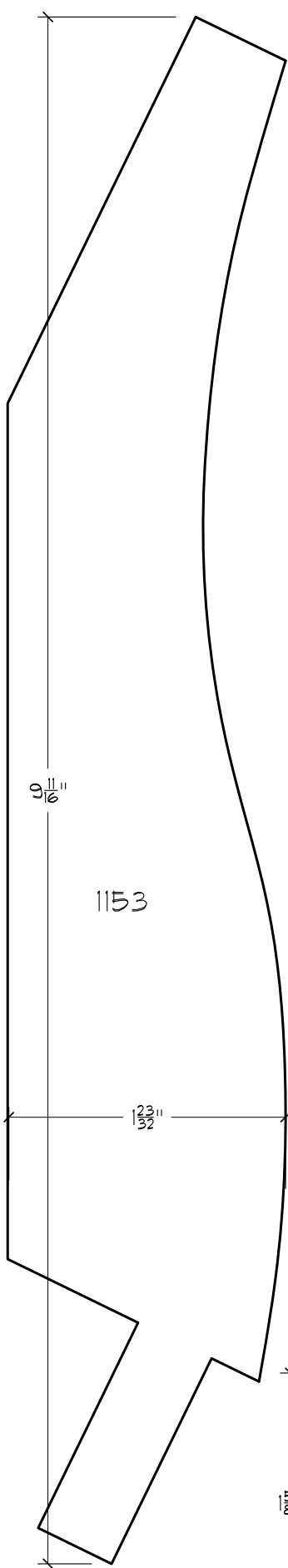

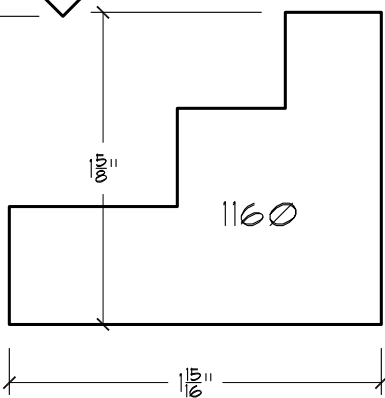
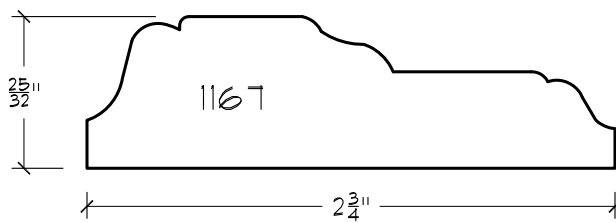
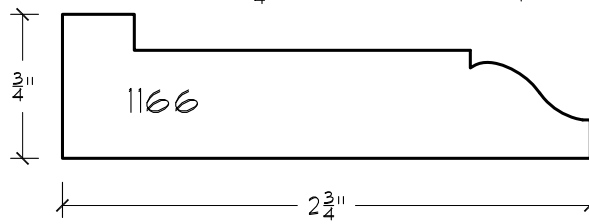
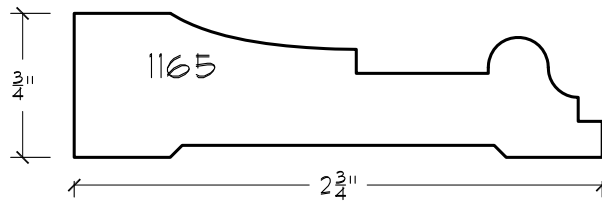
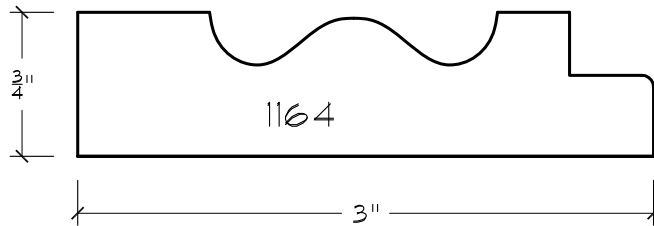
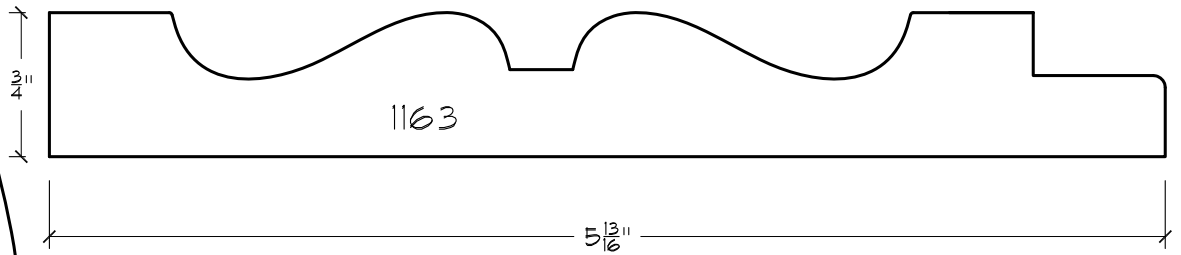
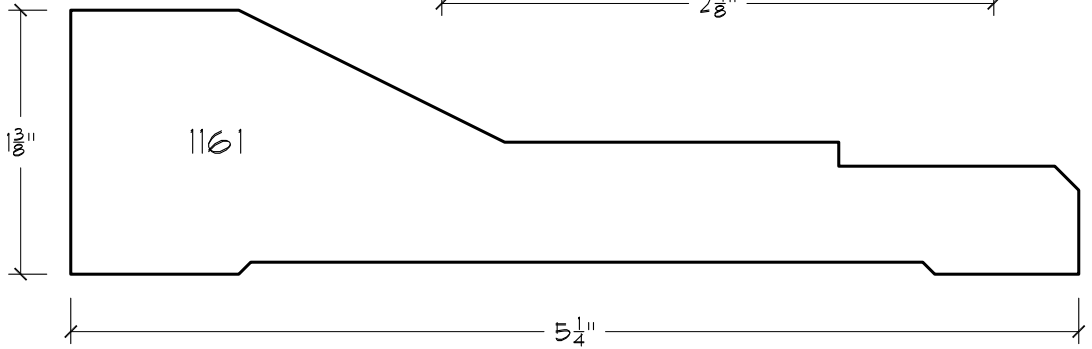
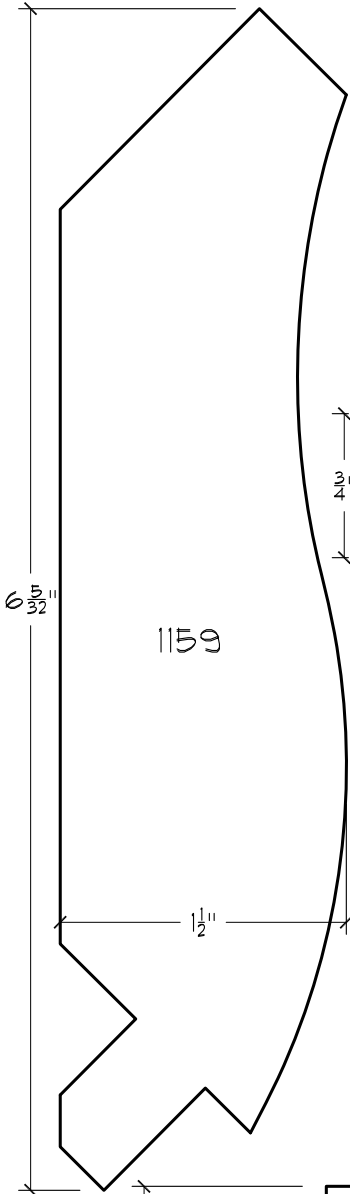
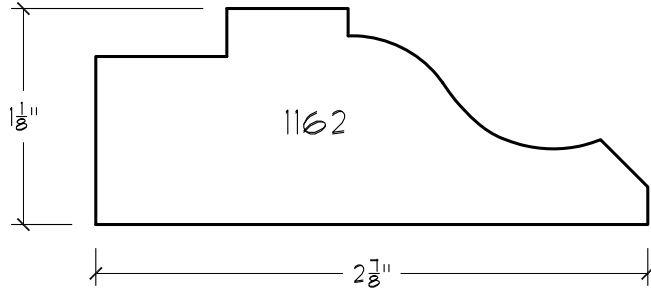
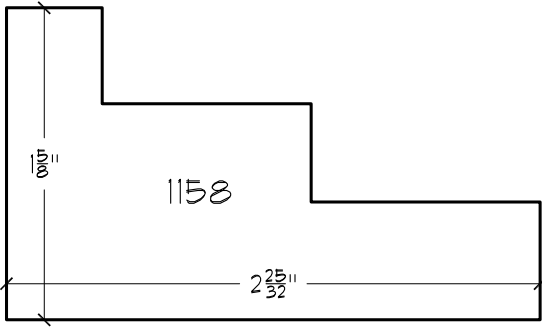

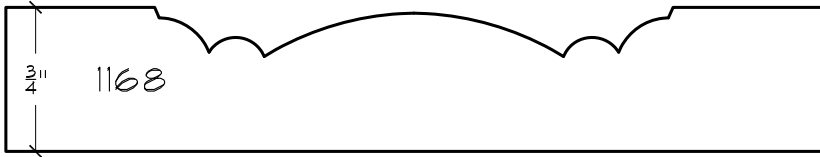

$4\frac{1}{4}$ "

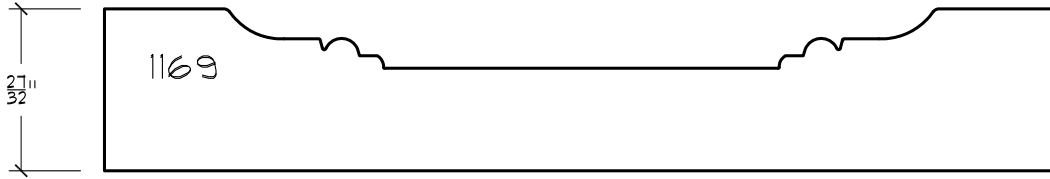

$2\frac{7}{32}$ "

$4\frac{31}{32}$ "

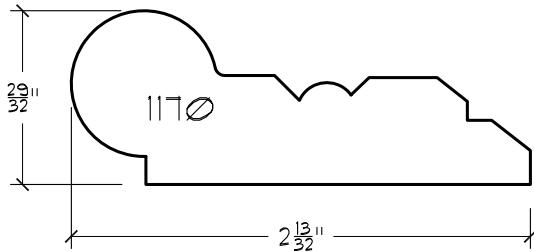

$2\frac{29}{32}$ "

$2\frac{13}{32}$ "

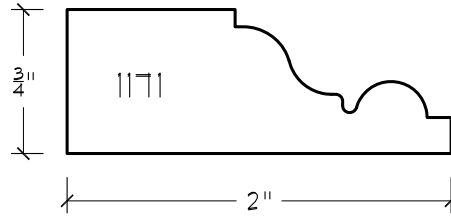

$\frac{3}{4}$ "

2"

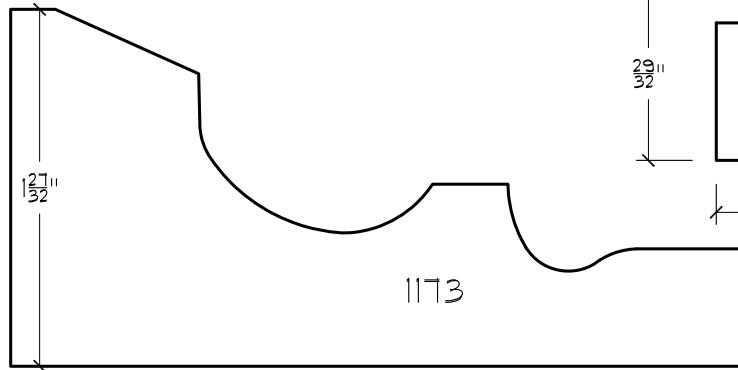

$1\frac{27}{32}$ "

$3\frac{13}{16}$ "

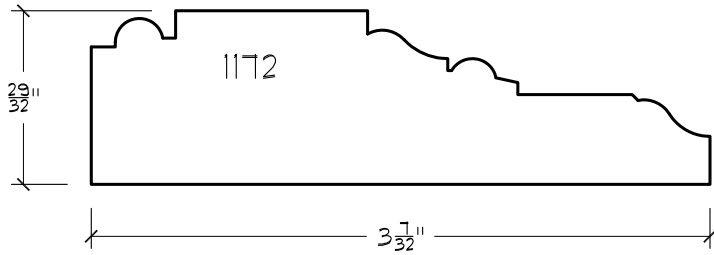

$2\frac{29}{32}$ "

$3\frac{1}{32}$ "

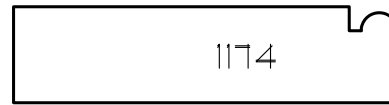

$3\frac{13}{16}$ "

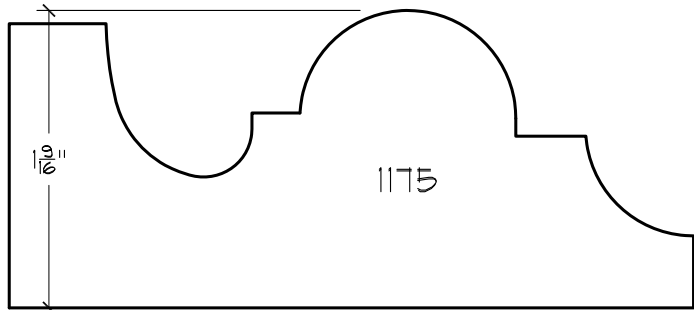

$1\frac{9}{16}$ "

$3\frac{9}{16}$ "

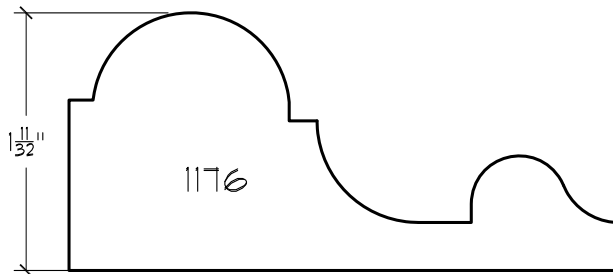

$1\frac{11}{32}$ "

$2\frac{13}{16}$ "



$4\frac{13}{16}$ "

$6\frac{13}{16}$ "

